

Medeco 18 Series Cylindrical Lever Lock

medeco
KeyMark

FEATURES & BENEFITS

Compatible key-in-lever cylinders and interchangeable cores	●	●
Built for reliability, accessibility for servicing, and durability	●	●
Attack resistant	●	●
High security cylinder is UL437 Listed & ANSI/BHMA A156.30 Certified	●	
Plated component parts resist rust and corrosion	●	●

Certification

All Medeco 18 Series locks are UL and c.UL listed for use on 3 hour, A label or lesser doors and are certified to conform to the requirements of ANSI/BHMA A156.2, Series 4000, Grade 2.

- ANSI A117.1 Accessibility Code
- California State Reference Code for levers returning to within 1/2" (12.7mm) of door surface.

General Specifications

Housing - Cold rolled steel, with zinc dichromated finish for rust resistance. Latch retractor is precision cast zinc. Extended one piece bearing sleeve offers added support for interlocking stainless steel tubes and provides for extra lever rigidity. Requires standard 2-1/8" (53.97mm) bore through door.

Thru-Bolts - Patented thru-bolt design allows for thru-bolting within standard 161 door preparations, which allows for easy retrofit without additional holes. Supplied with two support plates, which secure to face of door as well as accept thru-bolts from inside rose assembly.

Freewheeling Lever - Latch retraction mechanism disengages from lever handle when lever is locked. Built-in stops in the rose insert prevent lever from traveling beyond approximately 57 degrees. Heavy spring in rose insert ensures that the lever handle return to the horizontal position.

Latch - Brass with 1/2" (12.7mm) throw. Latch housing is steel, zinc dichromate finish for corrosion resistance. 7/8" (22.225mm)

Cylinder Technology:

Medeco recommends patented UL437 Listed, BHMA certified Medeco³ cylinder technology for Commercial locksets. The Biaxial patent expired in 2005 in the US and will expire in 2007 in Canada. "Original" cylinder technology was used in systems until patent expiration in 1986.

KeyMark cylinders offer patented control against unauthorized duplication of keys without the additional security features protecting against force or surreptitious attacks.

Lever Finishes:

- Bright Brass, clear coated (BHMA 605/US3)
- Satin Bronze, clear coated (BHMA 612/US10)
- Satin Bronze, oxidized and oil rubbed (BHMA 613/US10B)
- Bright Chrome Plate (BHMA 625/US26)
- Satin Chrome Plate (BHMA 626/US26D)
- Satin Brass, clear coated (BHMA 606/US4)

bore in edge of door is required. Supplied with sleeve for use with existing 1" (25.4mm) edge bore.

Latch Front - Brass, bronze or stainless steel. 2-1/4" (57.15mm) x 1-1/8" (28.57mm). Available with 1" (25.4mm) front latch for 2 3/8" (60.32) backset or 1" front for 2-3/4" (69.85mm) backset.

Exposed Trim - Levers are pressure cast zinc. Streamline rose scalp of brass or bronze complement other series of lever locks.

Rose Insert - Contain coil springs, which are permanent assemblies within rose inserts. The inside insert has graduating steps in two locations to prevent the rose scalp from loosening. A catch on the outside insert prevents rose scalp from working itself loose during installation.

Strike - Brass, bronze or stainless steel. ANSI A115.2, 4-7/8" (123.82mm) x 1-1/4" (31.75) curved lip strike. Optional 2-3/4" (69.85mm) x 1-1/8" (28.57mm) strike is available. All strikes have 1-1/4" (31.75mm) lip to center dimension.

Backset - 2-3/4" (69.85mm) standard, 3-3/4" (95.25mm) available. Also available with 5" (127mm) backset when used in conjunction with Grade 1 latch.

Door Thickness - 1-3/8" (34.92mm) to 1-3/4" (44.45mm).

Handing - Non-handed.

Packaging - 1 per box, 6 per carton.

Warranty - Limited three year warranty.

*Medeco³ Premium
High Security
18 Series Grade 2 Lever*

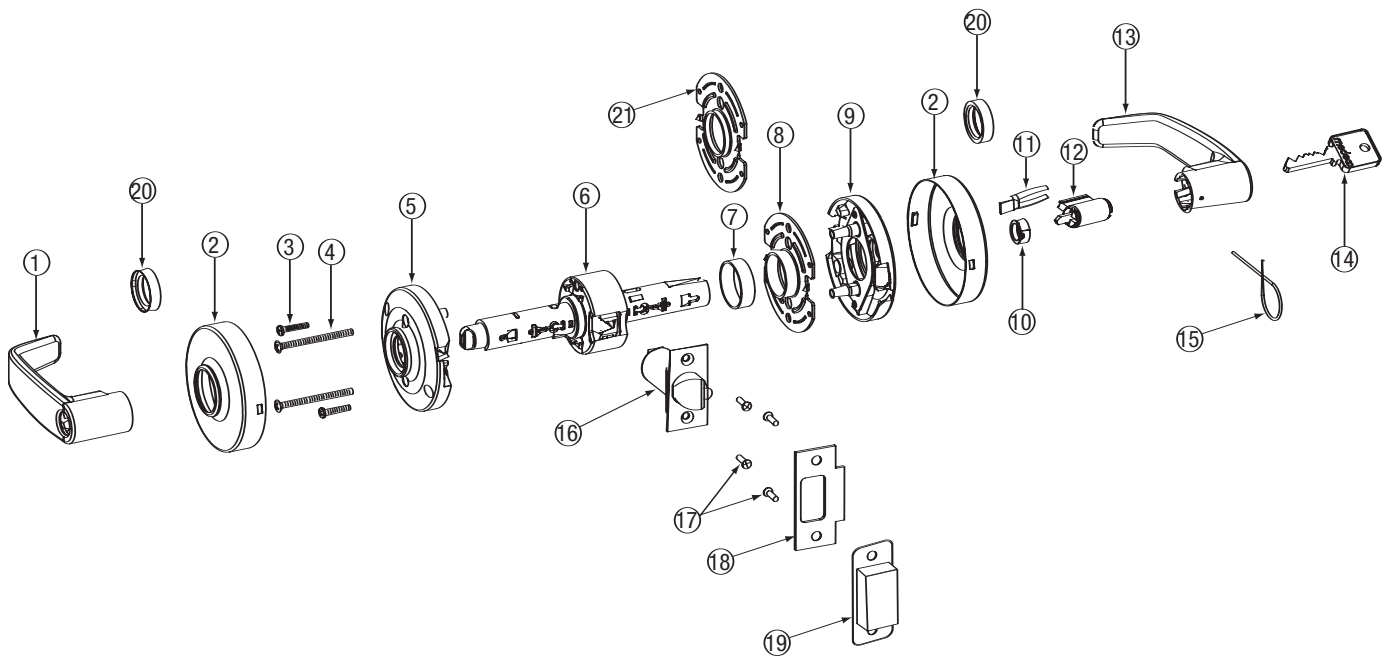

Item	Description
1	Inside Lever
2	Rose Scalp (2 Required)
3	Screws - Self-tapping #6 x 3/4" (2 Required)
4	Screws - Through bolt #8-32 x 2 1/8" (2 Required)
5	Inside Rose Insert Assembly
6	Chassis
7	Spacer
8	Outside Mounting Plate
9	Outside Rose Insert Assembly
10	Cylinder Spacer
11	Cylinder Retainer
12	Cylinder
13	Outside Lever
14	Key
15	Push Pin
16	Latch
17	Screws - Latch & Spring #8-32 x 3/4" (4 Required)
18	Strike
19	Strike Box
20	Bushing For 1 3/8" Thick Door Only
21	Outside Mounting Plate For 1 3/8" Thick Door Only

18 - XX X X X X - 0 X X XX

Series Prefix
18 = 18 Series Medium
Duty Lever Lockset

Cylinder Type
Interchangeable Core Lever
& Key-In-Lever Lockset

Locksets sold less cylinder

Function
Interchangeable Core Lever
33 = Entrance (ANSI F109)
34 = Classroom (ANSI F84)
35 = Storeroom (ANSI F86)
36 = Public Entrance (ANSI F88)
39 = Asylum (ANSI F87)
3B = Communicating (ANSI F80)
3C = Exterior (ANSI F82)
3D = Service Station (ANSI F92)

Key-In-Lever Lockset
31 = Privacy (ANSI F76)
32 = Passage (ANSI F75)
30 = Dummy Trim (single)
53 = Entrance (ANSI F109)
54 = Classroom (ANSI F84)
55 = Storeroom (ANSI F86)
56 = Public Entrance (ANSI F88)
59 = Asylum (ANSI F87)
3A = Dummy Trim (double)
5B = Communicating (ANSI F80)
5C = Exterior (ANSI F82)
5D = Service Station (ANSI F92)
5E = Exit (ANSI F89)
5G = Exit (ANSI F111)

Trim
Interchangeable Core Lever
3 = Sierra - for Medeco 32-SERIES I/C
4 = Sierra - for KeyMark I/C
5 = Broadway - for KeyMark I/C

Key-In-Lever Lockset
1 = Sierra
2 = Broadway

Door Thickness
1 = 1 3/8" to 1 3/4"

Backset
0 = Less latch, dummy trim only
1 = 2 3/4"
2 = 3 3/4"
3 = 2 3/8"

Finish
05 = Bright Brass
06 = Satin Brass
12 = Satin Bronze
13 = Oil Rubbed Bronze
25 = Bright Chrome
26 = Satin Chrome

Lever Option
1 = Abrasive coated, outside lever only
2 = Abrasive coated, inside lever only
3 = Abrasive coated, outside and inside levers
4 = Standard, uncoated lever

Strike
0 = Less strike, dummy trim only
1 = 4 7/8" curved lip ANSI strike
2 = 2 3/4" curved lip T-strike with dust box
3 = 2 3/4" curved full lip strike with dust box
4 = 2 3/4" curved full lip strike 1/4" radius
corners with dust box

Latch
0 = No latch, dummy trim only
1 = 1/2" throw, 2 3/4" backset,
1 1/8" x 2 1/4" front
4 = 1/2" throw, 3 3/4" backset,
1/8" x 2 1/4" front.
5 = 1/2" throw, 2 3/8" backset,
1" x 2 1/4" front
6 = 1/2" throw, 2 3/4" backset,
1" x 2 1/4" front

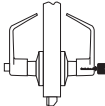
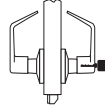
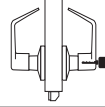
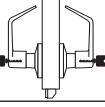
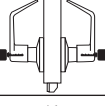
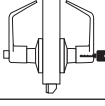
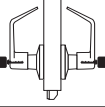
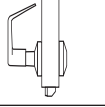
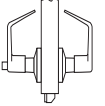
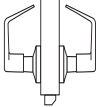
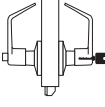
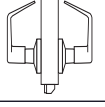
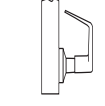
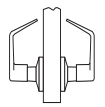
I8 Series Functions	Function # KIL I/C		ANSI #	Lever
Entry: Dead locking latch bolt operated by lever from either side except when outside lever is locked by pushing turn button inside. Key outside or operating inside lever releases turn button unlocking outside lever except when turn button had been rotated to keep outside lever locked. Inside turn button must be manually operated to unlock outside lever. Inside lever always operates latch bolt.	53	33	F109	
Classroom: Dead locking latch bolt operated by lever from either side except when outside lever is locked from outside by key. When outside lever is locked, latch bolt is operated by inside lever	54	34	F84	
Storeroom: Dead locking latch bolt operated by key in outside lever, or by operating inside lever. Outside lever is always inoperable.	55	35	F86	
Public Entrance: Dead locking latch bolt operated by lever from either side except when outside lever is locked from outside by key. When outside lever is locked, latch bolt is retracted by key in outside lever or by operating inside lever.	56	36	F88	
Asylum: Dead locking latch bolt operated by key in lever, from either side. Both levers always inoperable.	59	29	F87	
Service Station: Dead locking latch bolt operated by lever from either side except when outside lever is locked by push button inside. Key outside, operating inside lever or closing door releases push button unlocking outside lever except when slotted push is in a locked position. Inside lever always operates latch bolt.	5D	3D	F92	
Communicating: Dead locking latch bolt operated by lever from either side. Turning key in either lever locks or unlocks its own lever independently. Do not use on doors in rooms that have no other entrance.	5B	3B	F80	
Exit: Dead locking latch bolt operated by lever one side only at all times. Non removable blank trim outside.	5G		F111	
Privacy: Latch bolt operated by lever from either side. Outside lever is locked by push button inside and unlocked by emergency release outside, operating inside lever or closing door.	3I		F76	
Passage: Latch bolt operated by lever, from either side at all times.	32		F75	
Exterior: Dead locking latch bolt operated by lever from either side except when outside lever is locked by push button inside. When outside lever is locked, operating key in outside lever or operating inside lever unlocks push button and retracts latch bolt. Closing door does not release push button.	5C	3C	F82	
Exit: Dead locking latch bolt retracted by lever from inside at all times. Outside lever is always inoperable.	5E		F89	
Single Dummy Trim: Rigid trim for one side of door only. Used as pull or to match active trim.	30			
Full Dummy Trim: Rigid trim for both sides of door. Used as pulls or to match active trim.	3A			

EMBASSY

Grade 2 Embassy Levers, Medeco® I/C Cylinder

	Part Number	List Price
Entrance Function for Medeco I/C Core	18-3331111-014	224.70
Classroom Function for Medeco I/C Core	18-3431111-014	224.70
Storeroom Function for Medeco I/C Core	18-3531111-014	224.70
Public Entrance Function for Medeco I/C Core	18-3631111-014	289.80
Asylum Function for Medeco I/C Core	18-3931111-014	289.80
Communication Function for Medeco I/C Core	18-3B31111-014	289.80
Exterior Function for Medeco I/C Core	18-3C31111-014	224.70
Service Station Function for Medeco I/C Core	18-3D31111-014	255.15

Grade 2 Embassy Levers, Key In Lever (KIL) Cylinder

	Part Number	List Price
Entrance Function for KIL Cylinder	18-5311111-014	208.60
Classroom Function for KIL Cylinder	18-5411111-014	208.60
Storeroom Function for KIL Cylinder	18-5511111-014	208.60
Public Entrance Function for KIL Cylinder	18-5611111-014	268.10
Asylum Function for KIL Cylinder	18-5911111-014	268.10
Communicating Function for KIL Cylinder	18-5B11111-014	268.10
Exterior Function for KIL Cylinder	18-5C11111-014	208.60
Service Station Intruder Function for KIL Cylinder	18-5D11111-014	239.05

*All Grade 2 Levers on this page have the following specs: Sierra Trim, fits 1 3/8" - 1 3/4" thick doors, 2 3/4" backset, 1/2" throw latch x 1 1/8" x 2 1/4" faceplate, less cylinder; ANSI 4 7/8" strike, uncoated lever, 26 Finish.

Grade 2 Embassy® Levers Non Keyed

	Part Number	List Price
Exit Function Lever	18-5E11111-014	172.20
Exit Function Lever	18-5G11111-014	151.20
Privacy Function Lever	18-3111111-014	172.20
Passage Function Lever	18-3211111-014	151.20
Single Dummy Trim	18-301010-004	91.35
Full Dummy Trim	18-3A1010-004	176.40

NOTE: Prices shown are for 626 finished locksets. For all other finishes add \$10.50.

Embassy Components

Latches	Springlatch	Deadlatch	List Price
Grade 1 Embassy Latch, 1/2" Throw, 2 3/4" Backset, 1 1/8" Faceplate	CP-182520	CP-182530	33.60
Grade 1 Embassy Latch, 1/2" Throw, 2 3/4" Backset, Drive-In		CP-182540	33.60
Grade 1 Embassy Latch, 1/2" Throw, 3 3/4" Backset, 1 1/8" Faceplate	CP-182560	CP-182570	75.60
Grade 1 Embassy Latch, 3/4" Throw, 2 3/4" Backset, 1 1/8" Faceplate		CP-182550	119.70
Grade 2 Embassy Latch, 1/2" Throw, 2 3/4" Backset, 1 1/8" Faceplate	CP-182600	CP-182610	19.95
Grade 2 Embassy Latch, 1/2" Throw, 2 3/4" Backset, 1" Faceplate	CP-182660	CP-182730	19.95
Grade 2 Embassy Latch, 1/2" Throw, 3 3/8" Backset, 1" Faceplate	CP-182580	CP-182590	19.95

Embassy Lever Components

	Part Number	List Price
2 3/4" T-Strike 19 Series	CP-182650	8.40
4 7/8" ANSI Strike	CP-182640	16.80
5" Backset Extender- Use with CP-182520 or CP-182530 Only	CP-182720	52.50
2 3/4" T-Strike 18 Series	CP-182670	5.25
2 1/4" Full Lip D Strike	CP-182680	5.25
2 1/4" 1/4" Radius D Strike	CP-182690	5.25
Strike Box - ANSI Strike	CP-182700	3.15
Strike Box - T-Strike	CP-182710	3.15

Cylinders and I/C Cores For Embassy Locksets

	Part Number	Sub Price	List Price
High Security Key-In-Lever Cylinder	20◆20249	70.00	79.50
6 Pin LFIC Cylinder	32◆0201	68.50	78.00
5 Pin LFIC Cylinder (Adapter 94-0009 req.)	32◆0101	67.50	77.00

KeyMark® Cylinders and I/C Cores For Embassy

	Part Number	Sub Price	List Price
KeyMark® Key-In-Lever Cylinder	20K20249	35.45	44.50
6 Pin SFIC	33K600006	33.50	44.50
7 Pin SFIC	33K700006	33.50	44.50

Tailpieces

	Part Number	List Price
Tailpiece for Key-In-Lever Cylinder	CT-Y49	2.28
Tailpiece Package for LFIC Cylinder Includes Tailpiece and Tailpiece Holder	CT-V45	2.10
Tailpiece Package for SFIC Cylinder Includes 6 & 7 Pin Tailpieces	94-0205	3.15