

# VON DUPRIN®

## 88 Exit Device

### INDEX

	Introduction .....	3
<b>Exit Hardware</b>	Rim device .....	4
	Surface mounted vertical rod device.....	6
	Mortise lock device .....	5
<b>Fire Exit Hardware</b>	Rim device .....	7
	Surface mounted vertical rod device.....	9
	Concealed vertical rod device.....	10
	Mortise lock device .....	8
<b>Trim Selection</b>	.....	11-13
<b>Device Options</b>	E Electric rim device.....	16
	E7500 Electric mortise lock device .....	17
<b>Accessories</b>	Axle security pin .....	19
	Cover plates.....	19
	Cylinders .....	13
	Optional levers .....	13
	Power supplies .....	18
	Vertical rod and latch guard.....	18
<b>Additional Information</b>	ANSI grade, type & function.....	20
	Conversion kits.....	21
	Device dimensions.....	23
	Finishes .....	20
	Fire label ratings/applications .....	20
	Handing .....	22
	How-To-Order Information.....	22
	Nomenclature .....	23
	Operation options — lever and knob .....	13
	Popular double door applications .....	21
	Strike application/minimum stile .....	14
	Strike dimensions.....	15



# VON DUPRIN®

## 88 Exit Device

### INTRODUCTION

The proper selection and application of exit hardware, in addition to safety, are major concerns to all responsible manufacturers. Exit devices are a critical part of a door opening or access system and will provide safe and reliable service when properly applied and maintained. It is the policy of Von Duprin Division, Ingersoll-Rand Company, to design and manufacture exit devices to a high standard of quality and reliability in accordance with accepted U.S. domestic and international standards. All 88 series exit devices are UL listed for Accident Hazard and Fire Exit Hardware, and are tested in accordance to ANSI A156.3, 1994, Grade I.

It is intended that the information included in this publication, when properly used, will provide clear and reliable guidelines to the proper general selection and application. However, the scope of the information is necessarily limited.

Unusual operating conditions and environments and other external influences can affect the proper application of the products represented. Modifications of these products will also affect UL listings. It is recommended that whenever an unusual application condition exists, or when any modification of a product is considered, our engineers review the application.

Application engineering services are available to help ensure proper selection or to review any areas where users of Von Duprin products may have questions.

# VON DUPRIN® 88 Rim Device



299

**88 rim devices** for all types of single and double doors with mullion, UL listed for accident hazard installations. Covers stock hollow metal doors with 86 or 161\* cutouts.

## FEATURES

- Field reversible
- Field sizeable
- $\frac{3}{4}$ " (19mm) throw latch bolt
- Five popular finishes
- Hex key dogging

## DIMENSIONS

Crossbar height to finished floor	$36\frac{13}{16}$ " (935mm) at center
Crossbar projection — neutral	$4\frac{3}{4}$ " (121mm)
depressed	4" (102mm)
Crossbar length	42" (1067mm) field sizeable
Lock stile case	$8\frac{1}{4}$ " × $2\frac{3}{4}$ " × $\frac{15}{16}$ " (210mm × 70mm × 24mm)
Hinge stile case	6" × $1\frac{3}{4}$ " × $\frac{15}{16}$ " (152mm × 44mm × 24mm)
Crossbar tubing	1" (25mm)

## STRIKE AND FASTENERS

Device is furnished standard with 299 strike in dull black finish. All necessary mounting fasteners are included. Optional strikes and finishes must be specified. For strike applications, dimensions, and minimum door stile information, refer to pages 14-15.

## DEVICE OPTIONS

E88 Electric rim device, page 16.

\*Not applicable with all strike and mullion combinations, consult factory.

## OUTSIDE TRIM

### Standard

880NL-RV  
880TP-RV  
880DT  
880K-RV  
373L

### Optional

608NL-RV  
608TP-RV  
608DT  
606K-RV  
880EO

For complete outside trim information, see pages 11-13.

**How-To-Order information on all devices, see page 22.**

# VON DUPRIN®

## 88 Mortise Lock Device



**8875 mortise lock devices** for all types of single or double doors, UL listed for accident hazard installations. Fits stock hollow metal doors with 86 cutouts and door stiles as narrow as 4<sup>3</sup>/<sub>4</sub>" (121mm).

The 7500 mortise lock is equipped with a <sup>3</sup>/<sub>4</sub>" (19mm) anti-friction latch bolt which is field reversible without removing the lock from the door. It has a nonhanded auxiliary bolt for deadlocking and a faceplate with an adjustable bevel. Field selection of functions are furnished standard. TP, K or L function may be field selected by removing a set screw. Electric locking or unlocking options are available, refer to pages 18-19.

### FEATURES

- Field sizeable
- <sup>3</sup>/<sub>4</sub>" (19mm) throw latch bolt
- Latch bolt deadlocking
- Five popular finishes
- Hex key dogging

### DIMENSIONS

Crossbar height to finished floor	36 <sup>13</sup> / <sub>16</sub> " (935mm) at center
Latch bolt height to finished floor	40 <sup>3</sup> / <sub>32</sub> " (1018mm) at center
Crossbar projection —	
neutral	4 <sup>7</sup> / <sub>8</sub> " (124mm)
depressed	4" (102mm)
Crossbar length	42" (1067mm) field sizeable
Lock stile case	8 <sup>1</sup> / <sub>4</sub> " × 2" × <sup>15</sup> / <sub>16</sub> " (210mm × 51mm × 24mm)
Hinge stile case	6" × 1 <sup>3</sup> / <sub>4</sub> " × <sup>15</sup> / <sub>16</sub> " (152mm × 44mm × 24mm)
Crossbar tubing	1" (25mm)
Lock case	4 <sup>5</sup> / <sub>8</sub> " × 5 <sup>3</sup> / <sub>4</sub> " × 1 <sup>3</sup> / <sub>16</sub> " (117mm × 146mm × 46mm)
Face plate	1 <sup>1</sup> / <sub>4</sub> " × 8" × <sup>7</sup> / <sub>32</sub> " (32mm × 203mm × 6mm)
Cylinder backset	2 <sup>3</sup> / <sub>4</sub> " (70mm)

### OUTSIDE TRIM

#### Standard

- 880NL-M
- 880TP-M
- 880DT
- 880K-M
- 373L

#### Optional

- 608NL-M
- 608TP-M
- 608DT
- 606K-M
- 880EO

For complete outside trim information, see pages 11-13.

### STRIKE AND FASTENERS

Device is furnished with standard 575 strike in dull black. All necessary mounting fasteners are included. Optional strikes and finishes must be specified. For strike applications, dimensions and minimum door stile information, refer to pages 14-15.

### DEVICE OPTIONS

E8875 Electric mortise lock device, page 17.

**How-To-Order information on all devices, see page 22.**

# VON DUPRIN®

## 88 Surface Mounted Vertical Rod Device

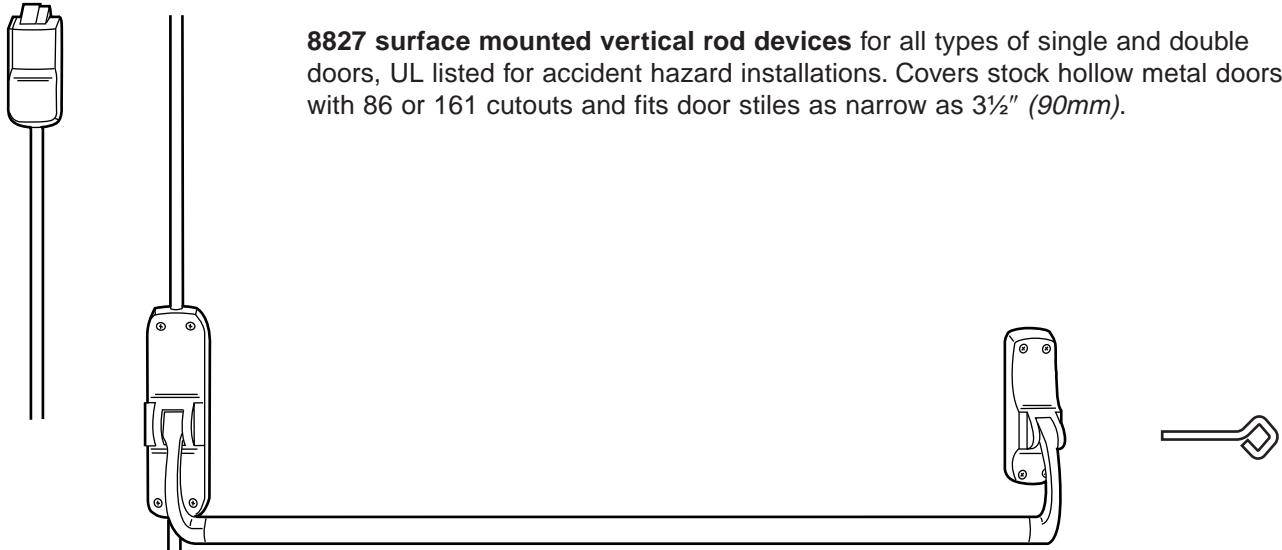

**8827 surface mounted vertical rod devices** for all types of single and double doors, UL listed for accident hazard installations. Covers stock hollow metal doors with 86 or 161 cutouts and fits door stiles as narrow as 3½" (90mm).

### FEATURES

- Fully reversible
- Field sizeable
- 5/8" (16mm) throw latch bolt
- Five popular finishes
- Hex key dogging

### DIMENSIONS

Crossbar height to finished floor	36 <sup>13</sup> / <sub>16</sub> " (935mm) at center
Crossbar projection — neutral	4 <sup>7</sup> / <sub>8</sub> " (121mm)
depressed	4" (102mm)
Crossbar width	42" (1067mm) field sizeable
Lock stile case	8 <sup>1</sup> / <sub>4</sub> " × 2" × 1 <sup>5</sup> / <sub>16</sub> " (210mm × 51mm × 24mm)
Hinge stile case	6" × 1 <sup>3</sup> / <sub>4</sub> " × 1 <sup>5</sup> / <sub>16</sub> " (152mm × 44mm × 24mm)
Crossbar tubing	1" (25mm)
Top and Bottom latch case	4" × 2" × 1 <sup>7</sup> / <sub>8</sub> " (102mm × 51mm × 48mm)
Vertical Rod	1/2" (13mm) tubing

Note: Maximum door undercut, 1/4" (6mm).

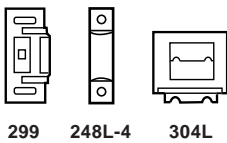

299 248L-4 304L

### OUTSIDE TRIM

#### Standard

880TP-RV  
880DT  
880K-RV  
373L  
377T × 880DT

#### Optional

608TP-RV  
608DT  
606K-RV  
880EO

For complete outside trim information, see pages 11-13.

### STRIKES AND FASTENERS

Device is furnished standard with 299 (in dull black), 248L-4 and 304L strikes. All necessary mounting fasteners are included. Optional strikes and finishes must be specified. For strike applications, dimensions and minimum door stile information, refer to pages 14-15.

Rod and latch guards are available. For complete information refer to page 18.

# VON DUPRIN®

## 88 Fire Exit Rim Mortise

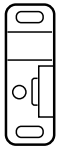

268

**88-F fire exit rim devices** for all types of 4' × 8' (1219mm × 2438mm) single and 8' × 8' (2438mm × 2438mm) double doors with 9954 mullion, UL listed, 3 hours.

### FEATURES

- Field sizeable
- Latch bolt deadlocking
- 3/4" (19mm) throw latch bolt
- Five popular finishes

### DIMENSIONS

Crossbar height to finished floor	36 <sup>13</sup> / <sub>16</sub> " (935mm) at centerr
Crossbar projection —	
neutral	4 <sup>7</sup> / <sub>8</sub> " (121mm)
depressed	4" (102mm)
Crossbar length	42" (1067mm) field sizeable
Lock stile case	8 <sup>1</sup> / <sub>4</sub> " × 2 <sup>3</sup> / <sub>4</sub> " × 1 <sup>5</sup> / <sub>16</sub> " (210mm × 70mm × 24mm)
Hinge stile case	6" × 1 <sup>3</sup> / <sub>4</sub> " × 1 <sup>5</sup> / <sub>16</sub> " (152mm × 44mm × 24mm)
Crossbar tubing	1" (25mm)

### STRIKE AND FASTENERS

Device is furnished with standard 268 strike in dull black. All necessary mounting fasteners are included. Optional finishes must be specified. For strike applications, dimensions, and minimum door stile information, refer to pages 14-15.

### DEVICE OPTIONS

E-88-F Electric Rim Device, page 16.

### OUTSIDE TRIM

#### Standard

880NL-RV  
880TP-RV  
880K-RV  
373L

#### Optional

608NL-RV  
608TP-RV  
606K-RV

For complete outside trim information, see pages 11-13.

**For How-To-Order Information on all devices, see page 22.**

# VON DUPRIN®

## 88 Fire Exit Mortise Lock Device



575

**8875-F fire exit mortise lock devices** for all types of 4' × 10' (1219mm × 3048mm) single or 8' × 8' (2438mm × 2438mm) double doors, UL listed, 3 hours. Fits door stiles as narrow as 4<sup>3</sup>/<sub>4</sub>" (121mm).

The 7500 mortise lock is equipped with a <sup>3</sup>/<sub>4</sub>" (19mm) anti-friction latch bolt which is field reversible without removing the lock from the door. It has a nonhanded auxiliary bolt for deadlocking and a faceplate with an adjustable bevel. Field selection of functions are furnished standard. TP, K, or L function may be field selected by removing a set screw. Electric locking or unlocking options are available; refer to pages 16-17.

### FEATURES

- Field sizeable
- <sup>3</sup>/<sub>4</sub>" (19mm) throw latch bolt
- Latch bolt deadlocking
- Five popular finishes

### DIMENSIONS

Crossbar height to finished floor	36 <sup>13</sup> / <sub>16</sub> " (935mm) at center
Latch bolt height to finished floor	40 <sup>3</sup> / <sub>32</sub> " (1018mm) at center
Crossbar projection — neutral	4 <sup>7</sup> / <sub>8</sub> " (124mm)
depressed	4" (102mm)
Crossbar length	42" (1067mm) field sizeable
Lock stile case	8 <sup>1</sup> / <sub>4</sub> " × 2" × <sup>15</sup> / <sub>16</sub> " (210mm × 51mm × 24mm)
Hinge stile case	6" × 1 <sup>3</sup> / <sub>4</sub> " × <sup>15</sup> / <sub>16</sub> " (152mm × 44mm × 24mm)
Crossbar tubing	1" (25mm)
Lock case (117mm × 146mm × 46mm)	4 <sup>5</sup> / <sub>8</sub> " × 5 <sup>3</sup> / <sub>4</sub> " × 1 <sup>3</sup> / <sub>16</sub> "
Face plate	1 <sup>1</sup> / <sub>4</sub> " × 8" × <sup>7</sup> / <sub>32</sub> " (32mm × 203mm × 6mm)
Cylinder backset	2 <sup>3</sup> / <sub>4</sub> " (70mm)

### OUTSIDE TRIM

#### Standard

880NL-M  
880TP-M  
880K-M  
373L

#### Optional

608NL-M  
608TP-M  
606K-M  
880EO

For complete outside trim information, see pages 11-13.

### STRIKE AND FASTENERS

Device is furnished with standard 575 strike in dull black. All necessary mounting fasteners are included. Optional strikes and finishes must be specified. For strike applications, dimensions, and minimum door stile information, refer to pages 14-15.

### DEVICE OPTIONS

E8875-F Electric mortise lock device, page 17.

**For How-To-Order Information on all devices, see page 22.**



# VON DUPRIN®

## 88 Fire Exit Surface Mounted Vertical Rod Device



**8827-F fire exit surface mounted vertical rod devices** for all types of 8' × 8' (2438mm × 2438mm) double doors, UL listed, 3 hours. Fits door stiles as narrow as 3<sup>3</sup>/<sub>4</sub>" (95mm).

### FEATURES

- Fully reversible
- Field sizeable
- 5/8" (16mm) throw latch bolt
- Five popular finishes

### DIMENSIONS

Crossbar height to finished floor	36 <sup>13</sup> / <sub>16</sub> " (935mm) at center
Crossbar projection — neutral	4 <sup>7</sup> / <sub>8</sub> " (124mm)
depressed	4" (102mm)
Crossbar length	42" (1067mm) field sizeable
Lock stile case	8 <sup>1</sup> / <sub>4</sub> " × 2" × 1 <sup>5</sup> / <sub>16</sub> " (210mm × 51mm × 24mm)
Hinge stile case	6" × 1 <sup>3</sup> / <sub>4</sub> " × 1 <sup>5</sup> / <sub>16</sub> " (152mm × 44mm × 24mm)
Crossbar tubing	1" (25mm)
Top or bottom latch case	4" × 2" × 1 <sup>7</sup> / <sub>8</sub> " (102mm × 51mm × 48mm)
Vertical rod	1/2" (13mm) tubing

Note: Maximum door undercut, 1/4" (6mm).

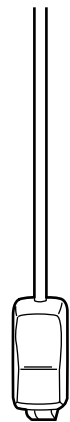

304L

### OUTSIDE TRIM

#### Standard

880TP-RV  
880K-RV  
373L  
377T × 880DT

#### Optional

608TP-RV  
606K-RV

For complete outside trim information, see pages 11-13.

### STRIKE AND FASTENERS

Device is furnished standard with 304L strike. All necessary mounting fasteners and the sex nuts and bolts required for the latches are included. For strike applications, dimensions, and minimum door stile information, refer to pages 14-15.

Rod and latch guards are available. For complete information refer to page 18.

**For How-To-Order Information on all devices, see page 22.**

# VON DUPRIN®

## 88 Fire Exit Concealed Vertical Rod Device

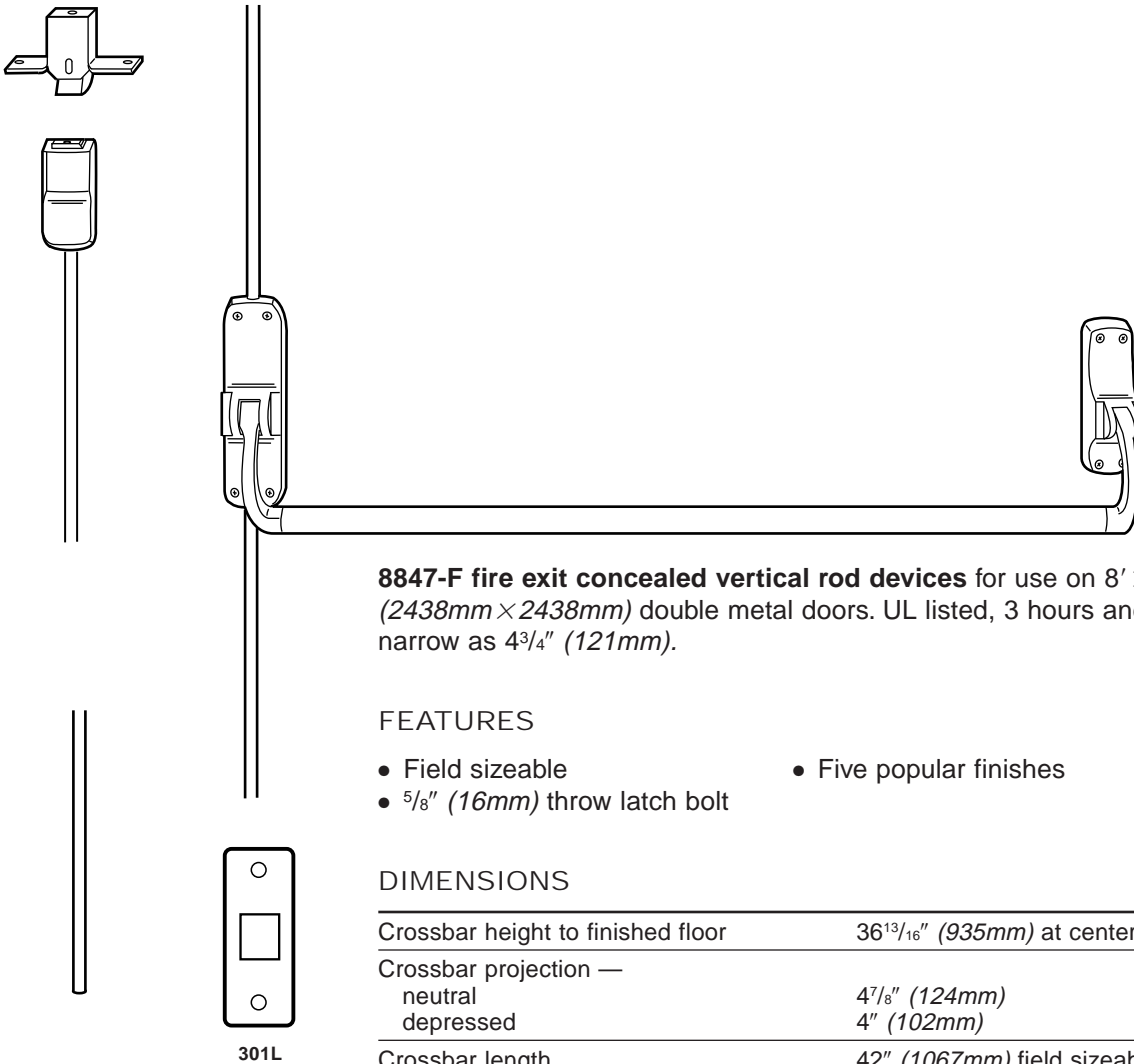

**8847-F fire exit concealed vertical rod devices** for use on 8' × 8' (2438mm × 2438mm) double metal doors. UL listed, 3 hours and fits door stiles as narrow as 4<sup>3</sup>/<sub>4</sub>" (121mm).

### FEATURES

- Field sizeable
- Five popular finishes
- <sup>5</sup>/<sub>8</sub>" (16mm) throw latch bolt

### DIMENSIONS

Crossbar height to finished floor	36 <sup>13</sup> / <sub>16</sub> " (935mm) at center
Crossbar projection —	
neutral	4 <sup>7</sup> / <sub>8</sub> " (124mm)
depressed	4" (102mm)
Crossbar length	42" (1067mm) field sizeable
Lock stile case	8 <sup>1</sup> / <sub>4</sub> " × 2" × <sup>15</sup> / <sub>16</sub> " (210mm × 51mm × 24mm)
Hinge stile case	6" × 1 <sup>3</sup> / <sub>4</sub> " × <sup>15</sup> / <sub>16</sub> " (152mm × 44mm × 24mm)
Crossbar tubing	1" (25mm)
Vertical rod	<sup>3</sup> / <sub>8</sub> " (10mm) hexagon

Note: Maximum door undercut, <sup>1</sup>/<sub>4</sub>" (6mm).

### STRIKE AND FASTENERS

Device is furnished standard with 301L strike. All necessary mounting fasteners are included. Optional strikes must be specified. For strike applications, dimensions, and minimum door stile information, refer to pages 14-15.

Rod and latch guards are available. For complete information refer to page 18.

### OUTSIDE TRIM

**Standard**

371L





376T × 880DT

For complete outside trim information, see pages 11-13.

**For How-To-Order Information on all devices, see page 22.**

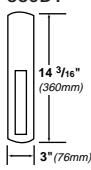
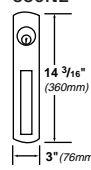
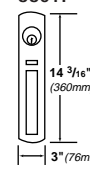
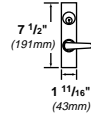
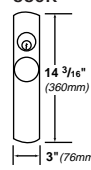
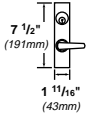
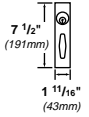
# VON DUPRIN®

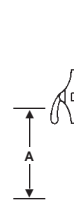
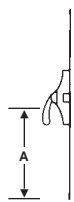
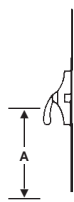
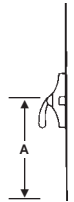
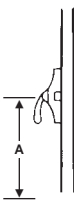
## 88 Trim Selection

Function	01 Exit Only	02 Pull When Dogged	03 Key Retracts Latchbolt	05 Key Retracts Thumbpiece	06 Key Locks Lever	08 Key Locks Knob	08 Key Locks Lever	11/12 Key Locks Thumbturn	
Trim Number and Dimensions		880DT 	880NL 	880TP 	371-L 	880K 	373-L 	377T or 376Tx 880DT-V 	
Device/Trim Center Line To Finished Floor									
Projection —	—	2" (51mm)	2" (51mm)	2" (51mm)	2 5/8" (67mm)	2 3/4" (70mm)	2 5/8" (67mm)	1 13/16" (46mm)	
Rim	Panic	88EO	88DT	88NL	88TP	—	88K	88L	—
	Fire	88EO-F	—	88NL-F▲	88TP-F▲	—	88K-F▲	88L-F■	—
	Ctr. Line	A 39 13/16" (1011mm) —	A 39 13/16" (1011mm) B 33 11/32" (847mm)	A 39 13/16" (1011mm) B 33 11/32" (847mm)	A 39 13/16" (1011mm) B 32 13/16" (833mm)	—	A 39 13/16" (1011mm) B 36 13/16" (935mm)	A 39 13/16" (1011mm) B 36 13/32" (935mm)	—
Mortise Lock	Panic	8875EO	8875DT	8875NL	8875TP	—	8875K	8875L	—
	Fire	8875EO-F	—	8875NL-F	8875TP-F	—	8875K-F	8875L-F	—
	Ctr. Line	A 39 13/16" (1011mm) —	A 39 13/16" (1011mm) B 33 1/2" (851mm)	A 39 13/16" (1011mm) B 33 1/2" (851mm)	A 39 13/16" (1011mm) B 33 1/2" (851mm)	—	A 39 13/16" (1011mm) B 38 9/16" (979mm)	A 39 13/16" (1011mm) B 38 9/16" (979mm)	—
Surface Mounted Vertical Rod	Panic	8827EO	8827DT	—	8827TP	—	8827K	8827L	8827TL
	Fire	8827EO-F	—	—	8827TP-F	—	8827K-F	8827L-F	8827TL-F
	Ctr. Line	A 39 13/16" (1011mm) —	A 39 13/16" (1011mm) B 33 1/2" (851mm)	—	A 39 13/16" (1011mm) B 33 1/2" (851mm)	—	A 39 13/16" (1011mm) B 38 5/16" (973mm)	A 39 13/16" (1011mm) B 38 5/16" (973mm)	A 39 13/16" (1011mm) B 38 5/16" (973mm)
Concealed Vertical Rod	Fire	8847EO-F	—	—	—	8847L-F	—	—	8847TL-F
	Ctr. Line	A 39 13/16" (1011mm) —	—	—	—	A 39 13/16" (1011mm) B 41 11/16" (1059mm)	—	—	A 39 13/16" (1011mm) B 53 1/2" (1359mm)
Additional SNB requirements	4/8/16	4,12	4	4,12	4	4,12	4,12	4	
Cylinder Type Required	Device Type	—	—	Rim	Rim	—	Rim	Mortise	—
	Rim	—	—	Mortise	Mortise	—	Mortise	Mortise	—
	Mortise	—	—	—	Rim	—	Rim	Mortise	Mortise
	Vert. Rod	—	—	—	—	Mortise	—	—	Mortise
C.V.R.	—	—	—	—	—	—	—	—	

▲ Requires Stainless Steel Trim for Wood or Composite Fire Doors.

■ Requires 889 Plate for Wood or Composite Fire Doors.

Note: 8827 uses 377T, 8847-F uses 376T.

# VON DUPRIN®

## 88 Trim Selection

### STANDARD TRIM

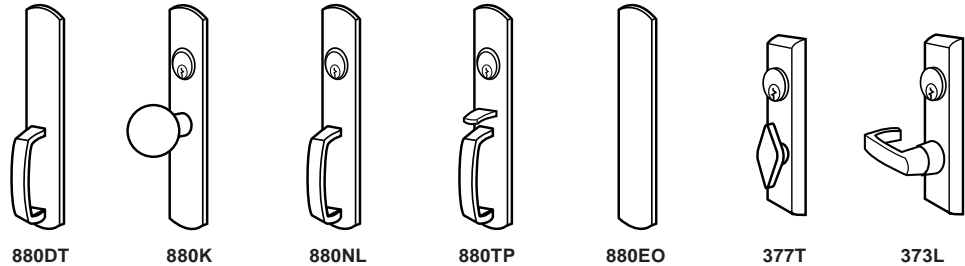

#### SERIES 880

Heavy 10 gauge (2.4mm) brass, bronze, or stainless steel. Available functions: 880DT, 880K, 880NL, and 880TP. Optional 880EO exit only trim plate is available. To order with the exit device, specify 88EOx880EO.

#### SERIES 377T

Thumbturn control has a forged brass  $\frac{7}{8}$ " (22mm) thick escutcheon. Often used with DT trim or pull. An NL cylinder plate is included for thumbturn operation only when key is used. BE blank escutcheon is available, specify 377T-BE.

#### SERIES 373L

Lever control has a forged brass  $\frac{7}{8}$ " (22mm) thick escutcheon. An NL cylinder plate is included for lever operation only when key is used. BE blank escutcheon is available, specify 373L-BE.

### OPTIONAL TRIM

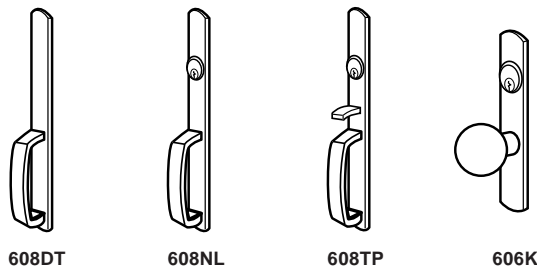

#### SERIES 608

Narrow design  $\frac{3}{16}$ " (5mm) thick brass, bronze, or stainless steel with flat pull grip. Available functions: 608DT, 608NL, and 608TP. When ordering with the exit device, specify 88NLx608NL.

#### SERIES 606K

Narrow design knob trim  $\frac{3}{16}$ " (5mm) thick brass, bronze, or stainless steel  $\frac{3}{16}$ " (5mm) escutcheon.

# VON DUPRIN® 88 Trim Selection

## LEVER DESIGN OPTIONS



## OPERATION OPTIONS — LEVER AND KNOB

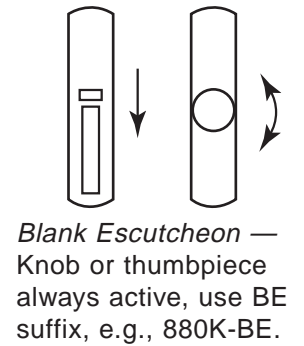
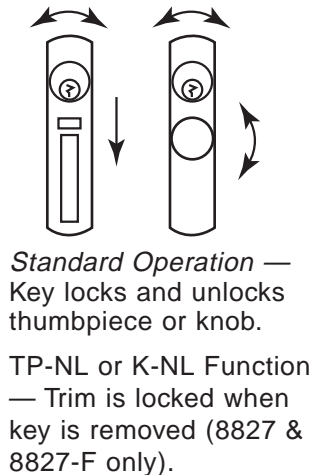
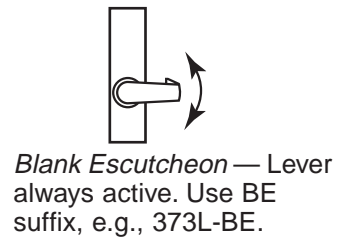
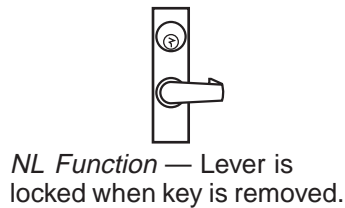
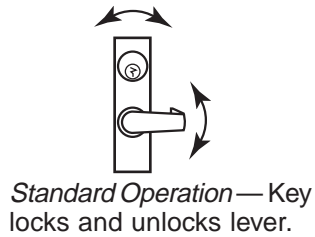

## CYLINDERS

Cylinders are not furnished with device or trim and must be specified when ordering. Rim, surface vertical rod and concealed vertical rod exit devices use rim type cylinders. Mortise lock exit devices and series 370 controls use mortise type cylinders.

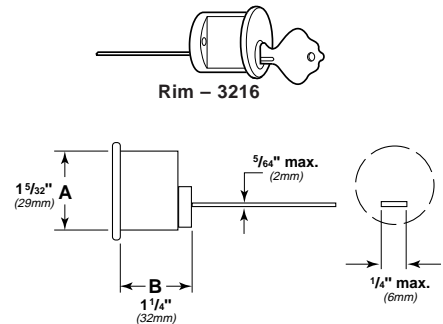
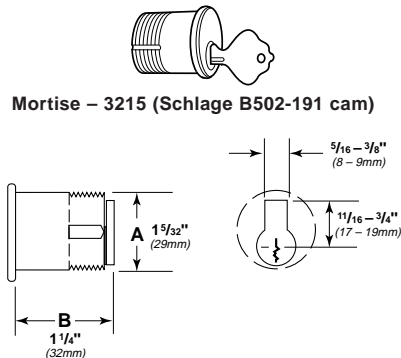

# VON DUPRIN®

## 88 Strike/Stile Information

### STRIKE APPLICATION/MINIMUM STILE

Device Type	Standard				Optional			
	Single door		Double door		Single door		Double door	
	Strike	Stile	Strike w/Mullion	Stile	Strike	Stile	Strike w/Mullion***	Stile
<b>88</b>	299	4 <sup>3</sup> / <sub>8</sub> " (111mm)	264×4954	4 <sup>11</sup> / <sub>16</sub> " (119mm)	264	4 <sup>1</sup> / <sub>8</sub> " (105mm)	299×5254/5654	4 <sup>1</sup> / <sub>4</sub> " (108mm)
					1409	3 <sup>3</sup> / <sub>8</sub> " (86mm)	264×5254/5654	4" (107mm)
					1606	3 <sup>15</sup> / <sub>16</sub> " (100mm)	264×4954	4 <sup>7</sup> / <sub>16</sub> " (113mm)
					—	—	1606×1654	4 <sup>1</sup> / <sub>4</sub> " (108mm)
					—	—	1609*	4" (107mm)
						1610**	4 <sup>7</sup> / <sub>16</sub> " (113mm)	
<b>88-F</b>	268	4 <sup>3</sup> / <sub>8</sub> " (111mm)	268×9954	4 <sup>11</sup> / <sub>16</sub> " (119mm)	—	—	—	—
	Strike	Stile	Strike	Stile	Strike	Stile	Strike	Stile
<b>8875</b>	575	4 <sup>3</sup> / <sub>4</sub> " (121mm)	—	—	—	—	575-2 576A-576B	4 <sup>3</sup> / <sub>4</sub> " (121mm)
<b>8875-F</b>	575	4 <sup>3</sup> / <sub>4</sub> " (121mm)	—	—	—	—	575-2 576A-576B	4 <sup>3</sup> / <sub>4</sub> " (121mm)
<b>8827</b> Latch Retraction	Strike	Stile	Strike	Stile	260U (Top) 385A (Bottom)	Single door Two vertical rod devices Vertical rod w/mortise lock device	2 <sup>13</sup> / <sub>16</sub> " (71mm) 2 <sup>1</sup> / <sub>2</sub> " (64mm) 4 <sup>3</sup> / <sub>4</sub> " (121mm)	2 <sup>13</sup> / <sub>16</sub> " (71mm) 2 <sup>1</sup> / <sub>2</sub> " (64mm) 4 <sup>3</sup> / <sub>4</sub> " (121mm)
	299 (Top) 304L/248L-4 (Bottom)	Single door Two vertical rod devices Vertical rod w/mortise lock device	2 <sup>13</sup> / <sub>16</sub> " (71mm) 2 <sup>1</sup> / <sub>2</sub> " (64mm) 4 <sup>3</sup> / <sub>4</sub> " (121mm)	2 <sup>13</sup> / <sub>16</sub> " (71mm) 2 <sup>1</sup> / <sub>2</sub> " (64mm) 4 <sup>3</sup> / <sub>4</sub> " (121mm)				
<b>8827-F</b>	Soffit Latch (Top) 304L (Bottom)	—	Two vertical rod devices Vertical rod w/mortise lock device	3 <sup>3</sup> / <sub>4</sub> " (95mm) 4 <sup>3</sup> / <sub>4</sub> " (121mm)	385A (Bottom)	—	—	—
<b>8847-F</b>	Soffit Latch (Top) 301L (Bottom)	—	Two vertical rod devices Vertical rod w/mortise lock device	4 <sup>3</sup> / <sub>4</sub> " (121mm) 4 <sup>3</sup> / <sub>4</sub> " (121mm)	304L (Bottom)	Single door Two vertical rod devices Vertical rod w/mortise lock device	4 <sup>3</sup> / <sub>4</sub> " (121mm) 3 <sup>3</sup> / <sub>4</sub> " (95mm) 4 <sup>3</sup> / <sub>4</sub> " (121mm)	4 <sup>3</sup> / <sub>4</sub> " (121mm)

\*Use for rim/vertical rod combination — consult factory.

\*\*Use for rim/vertical rod combination on stock hollow metal doors — consult factory.

\*\*\*For mullion information, refer to the General and Auxiliary catalog.

# VON DUPRIN®

## 88 Strike Information

### STRIKES FOR RIM DEVICES

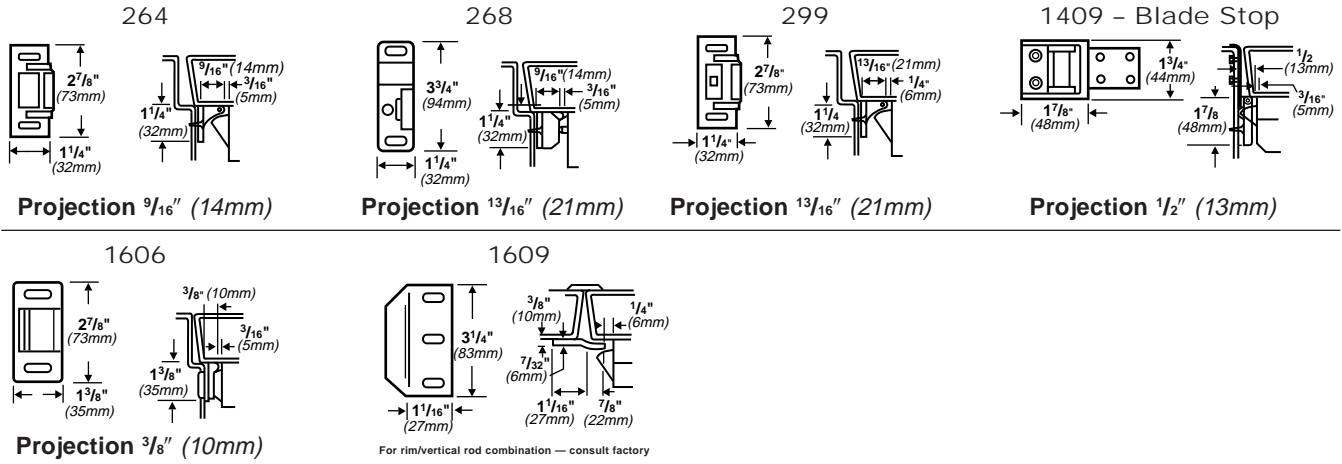

### STRIKES FOR VERTICAL ROD DEVICES

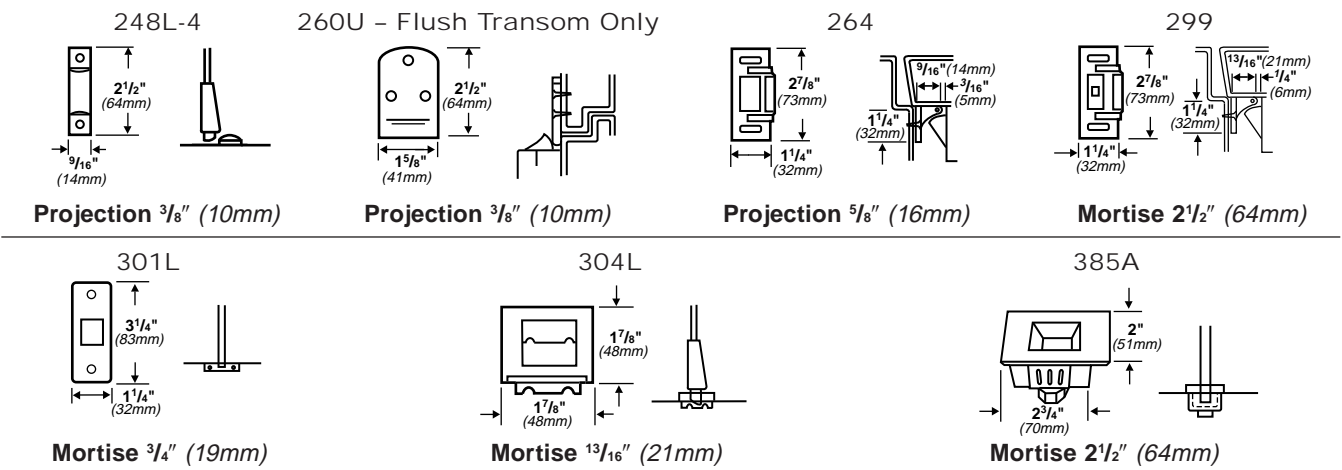

### STRIKES FOR MORTISE LOCK DEVICES

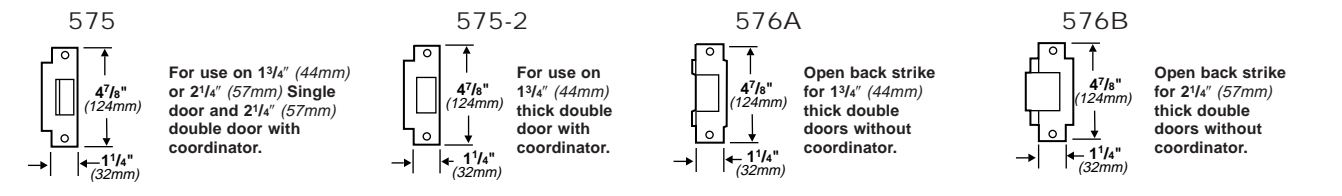

# VON DUPRIN®

## 88 Options

### E88 ELECTRIC RIM DEVICE



The E88 electric rim device provides remote unlocking capabilities. A control station operator can flip a switch to lock or unlock the outside trim. The 24 VDC solenoid assembly contains a SPDT signal switch to monitor the outside trim (locked or unlocked).

Available in fail safe or fail secure, 24 VDC or 24 VAC with rectifier. On fail secure models the trim returns to the locked mode after being operated either by the cylinder or momentary operation by the solenoid. The trim will remain unlocked if the solenoid remains energized.

**Note:** Some fire codes will require “Fail Safe” (FS) operation for stairwell doors. Be sure to specify the correct operation for your application.

#### Electrical Rating:

Each switch rated 0.3 Amp. 24 VDC.

#### To order, specify:

1. Use prefix “E”, example E88TP.
2. Handing, LHR or RHR, see page 22.
3. Voltage, 24 VDC or 24 VAC/SO.
4. FSE (fail secure) standard, specify FS (fail safe) when applicable.
5. Outside trim. “TP” or “K” function only

### POPULAR E88 APPLICATION

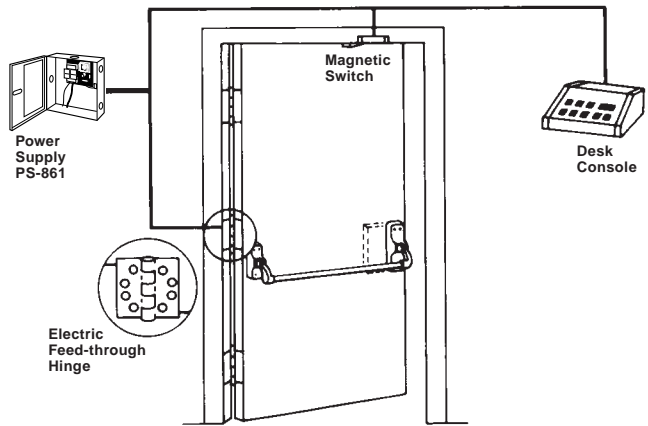

Adaptable for openings where continuous latching is required while the trim may be electrically locked or unlocked from a remote location — stairwells, exterior doors, etc.



# VON DUPRIN®

## 88 Options

### E8875 ELECTRIC MORTISE LOCK DEVICE

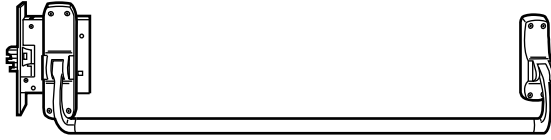

The E8875 electric mortise lock device has all the versatility and advantages of the 8875 mortise lock device, plus the advantage of being electrically controllable by a remote switching device, an access control or automatic device, or an automatic fire alarm system. The E8875 feature **controls the locking of the outside trim**. When unlocked, the door remains latched, preserving the fire rating of the door and making it particularly useful where codes permit locking, but require unlocking during a fire emergency. Key override is an NL type function.

#### Standard Features:

- Field reversible mortise lock
- 24 VDC continuous duty solenoid
- Tamper resistant (auxiliary dead latch)
- Silent operation
- Corrosion resistant
- Signalling functions
- Key mechanically retracts latchbolt.

#### Optional Features:

- Fail safe (locked when energized, unlocked when de-energized or during power failure, specify with suffix "FS").
- Fail secure (unlocked when energized — specify with suffix "FSE"). Outside trim automatically relocks, unless held unlocked electrically.
- 24 VAC (by adding SO option).
- 12 VDC or 12 VAC with SO option.

**Note:** Some Fire codes will require "Fail Safe" (FS) operation for stairwell doors. Be sure to specify the correct operation for your application.

#### To order, specify:

- 1a. E8875 or E8875F.
- 1b. E7500 (if lock only is required).
2. FS or FSE.
3. Voltage.
4. Handing, LHR or RHR, see page 22.
5. Outside trim. "TP," "K," or "L-BE" function only. When using with "L" function, no cylinder operation is available. Outside control is furnished "BE".

Consult Electrical Accessories catalog for additional information.

### POPULAR E8875 APPLICATION

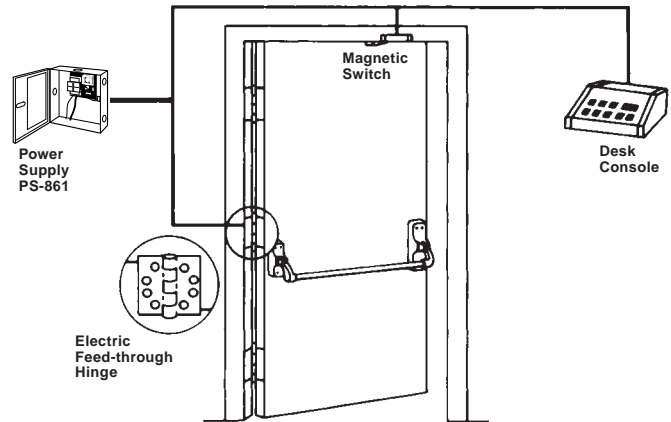

Adaptable for openings where continuous latching is required while the trim may be electrically locked or unlocked from a remote location — stairwells, exterior doors, etc.

# VON DUPRIN® 88 Accessories

## VERTICAL ROD AND LATCH GUARD — RG-27

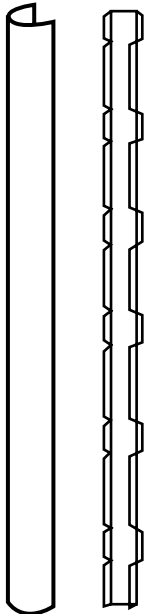

Series RG-27 Vertical Rod and Latch Guards protect the bottom rods of exit devices from the damaging impacts of carts or gurneys passing through doors. (If these bottom rods become damaged, the exit device will not function as intended and can jeopardize the ability to exit safely during an emergency.)

In addition to protecting the vertical rod, the guard provides a smooth, unobstructed surface so the door can be pushed open easily with the bumpers of a wheelchair. The latch guard portion is 10" high. The standard latch guard features a 45° ramp. The extended latch guard offers a continuous ramp in 3' or 4' widths.

All stainless steel construction, in US32D finish. Latch guards can cover latches as large as 1 1/4"W x 10"H x 1 7/8" projection.

### Models

**RG-27** — Rod and latch guard.  
**RG-27-3** — 3' (914mm) Extended rod and latch guard.

**RG-27-4** — 4' (1219mm) Extended rod and latch guard.

**RGO** — Rod guard only.

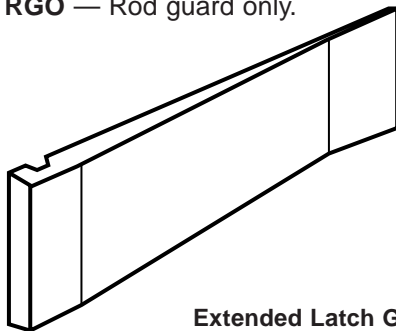

Extended Latch Guard

**LGO** — Latch guard only.

**LGO-3** — 3' (914mm) Extended latch guard only.

**LGO-4** — 4' (1219mm) Extended latch guard only.

### To order, specify:

1. Model number

## POWER SUPPLIES

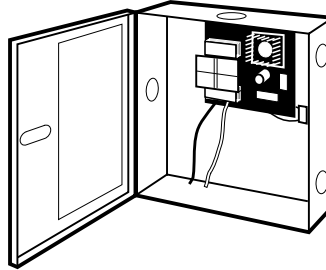

*Standard*

*UL Listed  
Class 2, Power Supply  
UL1012  
UL1310*

The series PS861 power supply is designed for electric locking or monitoring on single or double door applications. The output power is field selectable for either 24 VDC @ 1 ampere or 12 VDC @ 2 ampere. Standard input 120 VAC @ 0.6 ampere and 240 VAC @ 0.3 ampere available. Terminal block will accept up to 14 gauge stranded wire.

The gray enclosure is 10" x 10" x 4" (254mm x 254mm x 102mm) has a hinged cover, and is constructed of heavy 19 gauge steel. Six 1/2" (13mm) knockout holes are provided for conduit connection.

**Options include keylock cover and sealed lead acid battery pack.** The pair of batteries will provide back-up power for three hours at full load or seven hours at half load. Batteries will automatically recharge when failed power is restored.

### FOUR MODELS:

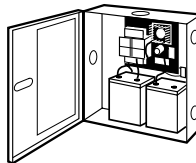

*With keylock  
and batteries*

PS861	Standard supply
PS861K	Standard supply with keylock cover
PS861B	Battery backup
PS861BK	Battery backup and keylock cover

### To order, specify:

1. Model number

# VON DUPRIN®

## 88 Accessories

### COVER PLATE KITS

#### Devices

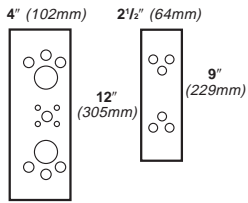

882

#### 882 Kit

For 88 rim devices applied over mortise lock or discontinued device cutouts.

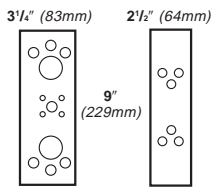

887

#### 887 Kit

Required for 88 rim/ 8827 vertical rod device combinations on pairs of doors with ANSI 161 cutout. (The 88 rim device backset is increased and exposes the 161 cutout when used with 8827).

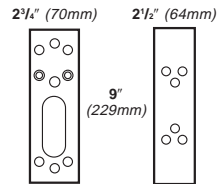

888

#### 888 Kit

Required for 8875 mortise or 8827 vertical rod devices on doors with ANSI 161 cutouts (device center case will not cover stock cutout).

#### Controls

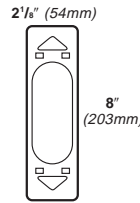

#10WDA

#### #10 WDA Kit

Required when 373L or 377T controls are used on wood doors with the following devices: 88L, 8827L, 8827TL, 8827TL-F, or 8875L (kit covers cutout and prevents control from damaging door).

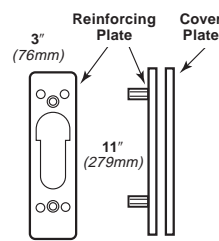

889

#### 889 Kit

Required when 373L controls are used with sex bolts (sex bolts must be used on wood or composite fire doors). Four studs on cover plate allow through-bolting to the device center case.

#### To order, specify:

1. Kit number.
2. Finish.
3. Device type (889 kit only).

#### AXLE SECURITY PIN

Non-removable security pin can be inserted into lever arm axle to prevent tampering or removal of lever arm.

To order, specify Part Number 033022 (**package of 50**).

# VON DUPRIN®

## 88 Additional Information

### FINISHES

Color	US Number	BHMA Number
Brass, Polished	US 3	BHMA605
Brass, Dull	US4	BHMA606
Brass, Dull – oxidized	US10B	BHMA613
Chrome, Polished	US26	BHMA625
Chrome, Dull	US26D	BHMA626

Other finishes available, consult factory.

### UL LISTED — FIRE EXIT HARDWARE LABEL/OPENING SIZE

Exit Device	Single Door	Double Doors			
		With Mullion	Same Direction Vert./Vert.	Same Direction Vert./Mortise	Double Egress
88-F	3 Hour 4' × 8'	3 Hour 8' × 8'	—	—	—
8875-F	3 Hour 4' × 10'	—	—	3 Hour 8' × 10'	—
8827-F	—	—	90 Min.* 8' × 8'	3 Hour 8' × 8'	3 Hour 8' × 8'
8847-F	—	—	90 Min. 8' × 8'	3 Hour 8' × 8'	3 Hour 8' × 8'

\*Wood door applications, 45 minute label.

### ANSI GRADE, TYPE & FUNCTION

Function	Grade 1 Type 1	Grade 1 Type 2	Grade 1 Type 3	Grade 1 Type 8
01	88EO, 88EO-F	8827EO, 8827EO-F	8875EO, 8875EO-F	8847EO-F
02	88DT	8827DT	8875DT	—
03	88NL, 88NL-F	—	8875NL, 8875NL-F	8847NL-F
05	88TP, 88TP-F	8827TP, 8827TP-F	8875TP, 8875TP-F	—
06	—	8827TP-NL, 8827TP-NL-F	—	—
08	88K, 88K-F 88L, 88L-F	8827K, 8827K-F 8827L, 8827L-F	8875K, 8875K-F 8875L, 8875L-F	8847L-F
09	88L, 88L-F	8827K-NL, 8827K-NL-F 8827L, 8827L-F	8875L, 8875L-F	8847L-F
11-12	—	8827TL, 8827TL-F	—	8847TL-F

# VON DUPRIN®

## 88 Additional Information

### POPULAR DOUBLE DOOR APPLICATIONS

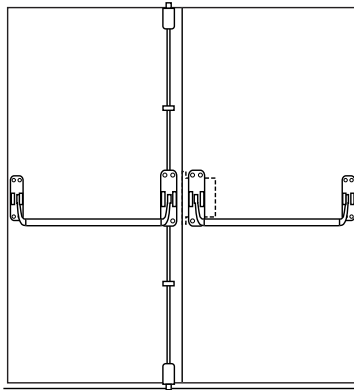

Mortise lock and surface mounted vertical rod device combination — same direction

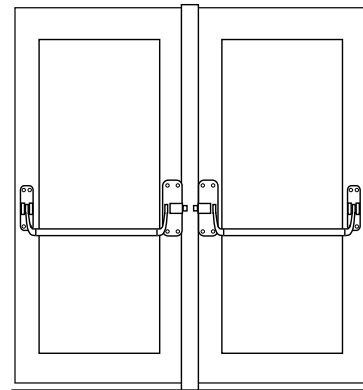

Two rim devices with mullion — same direction

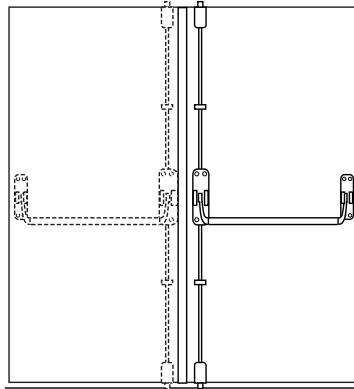

Two vertical rods — double egress

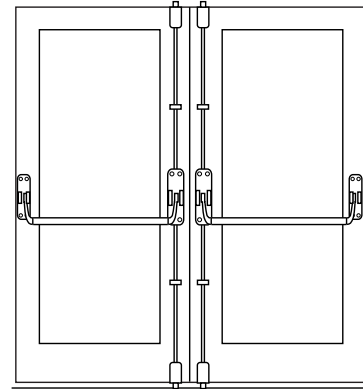

Two surface mounted vertical rod devices — same direction (do not use with overlapping astragal)

### FUNCTION CONVERSION KITS

Device Type	Kit	Converts from –	Converts to –	Trim Included
<b>88</b>	CK-NL	TP, K	NL	880NL-R
	CK-TP	EO, DT, NL, K	TP	880TP-R
	CK-K	EO, DT, NL, TP	K	880K-R
	CK-K × 373L	EO, DT, NL, TP	L	373L × 889 Plate (NL, DT, TP)
<b>88-F</b>	CK-NL-F	TP-F, K-F	NL-F	880NL-R
	CK-TP-F	EO-F, NL-F, K-F	TP-F	880TP-R
	CK-K-F	EO-F, NL-F, TP-F	K-F	880K-R
	CK-K-F × 373L	EO-F, NL-F, TP-F	L-F	373L × 889 Plate (NL, DT, TP)
<b>8827, 8827-F</b>	CK27-TP	EO, DT, K (std. or fire)	TP (std. or fire)	880TP-V
	CK27-K	EO, DT, TP (std. or fire)	K (std. or fire)	880K-V
	CK27-K × 373L	EO, DT, TP (std. or fire)	L (std. or fire)	373L × 889 Plate (NL, DT, TP)

Conversion kits are required for 88 rim and 8827 devices. To convert functions on 8847 and 8875 devices, only new trim is required. The 8875 mortise lock is field convertible for function.

# VON DUPRIN®

## 88 Additional Information

### HOW-TO-ORDER INFORMATION

#### Rim and mortise lock devices, specify:

1. Exit device model number with trim selection.  
Examples: 88EO (Exit only with no outside trim).  
88TP (Includes standard 880TP thumbpiece trim).  
88TP×608TP (Includes the optional 608TP thumbpiece trim).
2. Door width if greater than 4' (1219mm).
3. Door thickness if other than 1<sup>3</sup>/<sub>4</sub>" (44mm).
4. Door and frame material if other than hollow metal.
5. Finish, see page 17.
6. Handing required on "L" function, "F" fire devices, and the E-88. Specify LHR or RHR. See diagram below.
7. "SNB" when using sex nuts and bolts.

#### Vertical rod devices, specify:

1. Exit device number with trim selection. Examples: 8827EO (Exit only, no outside trim). 8827TP (Includes 880TP thumbpiece trim). 8827TP×608TP (Includes the optional 608TP thumbpiece trim).
2. Door width of greater than 4' (1219mm).
3. Door thickness if other than 1<sup>3</sup>/<sub>4</sub>" (44mm).
4. Door and frame material if other than hollow metal.
5. Door height if greater than 7' (2134mm), extension rods must be ordered.
6. Finish, see page 17.
7. Handing, LHR or RHR, required on "L" and "F" fire devices. See diagram below.
8. "SNB" when using sex nuts and bolts.

**Pullman latches** are optional for 8827 devices. Latchbolts remain extended at all times. Specify "Pullman Latch" when required.

### HANDING

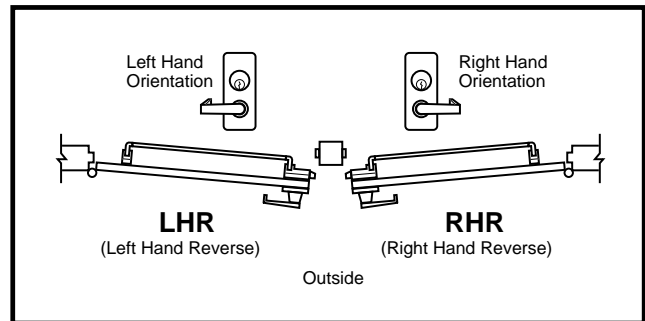

# VON DUPRIN®

## 88 Additional Information

### NOMENCLATURE

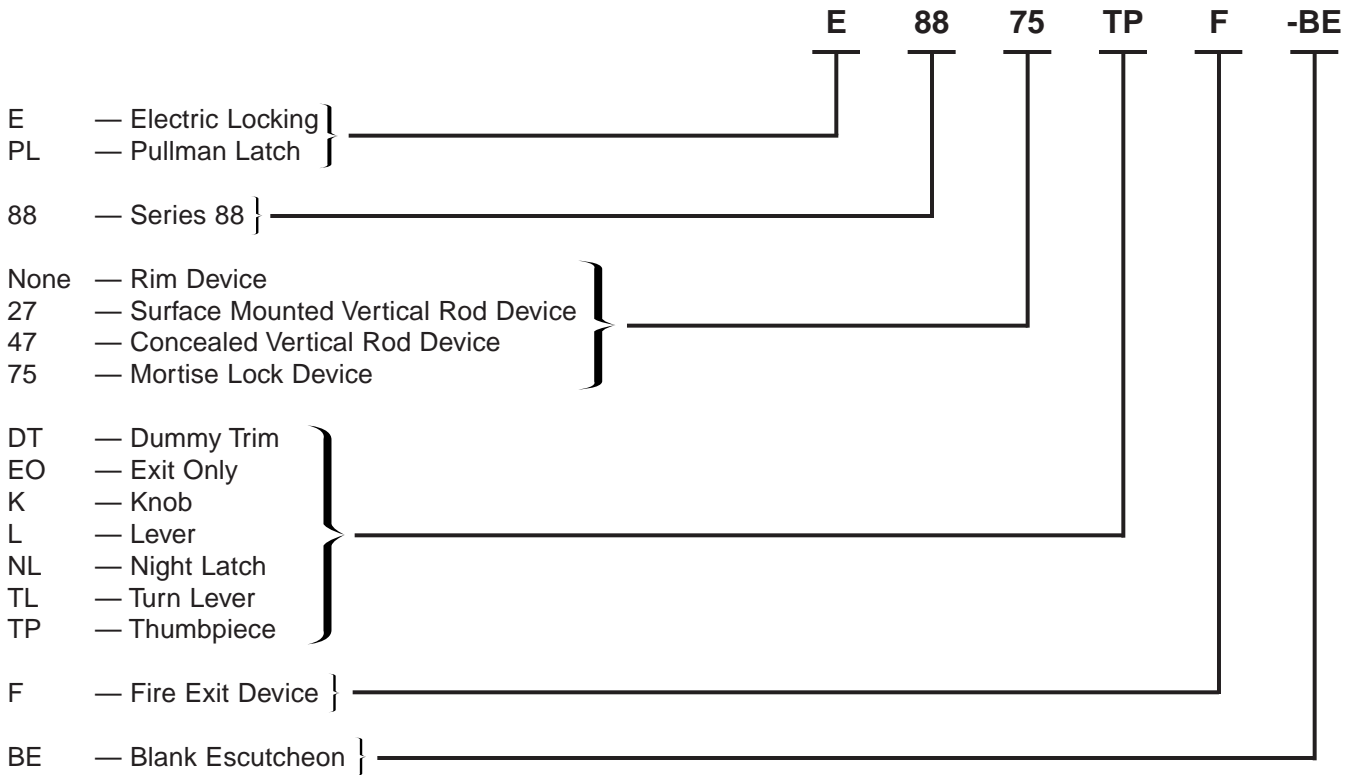

### DIMENSIONS

