



WE ARE PROUD TO RECOMMEND
ARROW

CYLINDRICAL KEYS		TUBULAR LOCKS	CYLINDRICAL KNOBS	SFIC	DEADBOLTS	DOOR CLOSERS	INTER-CONNECTED LOCKS	ALARM HARDWARE
ML	RL	C	H S MK RH	Points Plus	D E	SD0N SD1SN	IL	ALARM HARDWARE
17 functions (ML) 23 functions (RL) 3 lever designs 4 finishes IC core option	19 functions (ML) 23 functions (RL) 3 lever designs 4 finishes IC core option	17 functions (ML) 23 functions (RL) 3 lever designs 4 finishes IC core option	19 functions (ML) 23 functions (RL) 3 lever designs 4 finishes IC core option	19 functions (ML) 23 functions (RL) 3 lever designs 4 finishes IC core option	19 functions (ML) 23 functions (RL) 3 lever designs 4 finishes IC core option	19 functions (ML) 23 functions (RL) 3 lever designs 4 finishes IC core option	19 functions (ML) 23 functions (RL) 3 lever designs 4 finishes IC core option	19 functions (ML) 23 functions (RL) 3 lever designs 4 finishes IC core option
ML	RL	C	H S MK RH	Points	D E	SD0N SD1SN	IL	ALARM HARDWARE
17 functions (ML) 23 functions (RL) 3 lever designs 4 finishes IC core option	19 functions (ML) 23 functions (RL) 3 lever designs 4 finishes IC core option	17 functions (ML) 23 functions (RL) 3 lever designs 4 finishes IC core option	19 functions (ML) 23 functions (RL) 3 lever designs 4 finishes IC core option	19 functions (ML) 23 functions (RL) 3 lever designs 4 finishes IC core option	19 functions (ML) 23 functions (RL) 3 lever designs 4 finishes IC core option	19 functions (ML) 23 functions (RL) 3 lever designs 4 finishes IC core option	19 functions (ML) 23 functions (RL) 3 lever designs 4 finishes IC core option	19 functions (ML) 23 functions (RL) 3 lever designs 4 finishes IC core option
ML	RL	C	H S MK RH	Points	D E	SD0N SD1SN	IL	ALARM HARDWARE
17 functions (ML) 23 functions (RL) 3 lever designs 4 finishes IC core option	19 functions (ML) 23 functions (RL) 3 lever designs 4 finishes IC core option	17 functions (ML) 23 functions (RL) 3 lever designs 4 finishes IC core option	19 functions (ML) 23 functions (RL) 3 lever designs 4 finishes IC core option	19 functions (ML) 23 functions (RL) 3 lever designs 4 finishes IC core option	19 functions (ML) 23 functions (RL) 3 lever designs 4 finishes IC core option	19 functions (ML) 23 functions (RL) 3 lever designs 4 finishes IC core option	19 functions (ML) 23 functions (RL) 3 lever designs 4 finishes IC core option	19 functions (ML) 23 functions (RL) 3 lever designs 4 finishes IC core option

2008 Product Catalog

ASSA ABLOY, the global leader in door opening solutions





WE ARE PROUD TO RECOMMEND
ARROW

THE RIGHT PRODUCTS

PREMIER	MORTISE LOCKS	CYLINDRICAL LEVERS	TUBULAR LOCKS	CYLINDRICAL KNOBS	DEADBOLTS	DOOR CLOSERS	INTER-CONNECTED LOCKS	ALARMED HARDWARE	EXIT DEVICES
PR P PR PR 100 functions 15 lever designs 21 lever designs 40 finishes 1C core option	ML ML 17 functions (M) 3 lever designs (ML) 2 lever designs (L) 4 finishes 1C core option (ML)	Q W ML L RL 17 functions (M) 7 functions (L) 3 lever designs (ML) 2 lever designs (L) 4 finishes 1C core option (ML)	T T T T 17 functions (M) 7 functions (L) 3 lever designs (ML) 2 lever designs (L) 4 finishes 1C core option (ML)	C C C C 17 functions (M) 7 functions (L) 3 lever designs (ML) 2 lever designs (L) 4 finishes 1C core option (ML)	D D D D 7 functions (M) 3 lever designs (ML) 2 lever designs (L) 4 finishes 1C core option (ML)	DC DC DC DC 5 finishes 1C core option	IL IL IL IL 3 finishes 1C core option	AL AL AL AL 3 finishes 1C core option	ED ED ED ED 4 finishes 1C core option
CLASSIC C C C 100 functions 15 lever designs 21 lever designs 40 finishes 1C core option	ML ML 17 functions (M) 3 lever designs (ML) 2 lever designs (L) 4 finishes 1C core option (ML)	Q W ML L RL 17 functions (M) 7 functions (L) 3 lever designs (ML) 2 lever designs (L) 4 finishes 1C core option (ML)	T T T T 17 functions (M) 7 functions (L) 3 lever designs (ML) 2 lever designs (L) 4 finishes 1C core option (ML)	C C C C 17 functions (M) 7 functions (L) 3 lever designs (ML) 2 lever designs (L) 4 finishes 1C core option (ML)	D D D D 7 functions (M) 3 lever designs (ML) 2 lever designs (L) 4 finishes 1C core option (ML)	DC DC DC DC 5 finishes 1C core option	IL IL IL IL 3 finishes 1C core option	AL AL AL AL 3 finishes 1C core option	ED ED ED ED 4 finishes 1C core option
VALUE V V V 100 functions 15 lever designs 21 lever designs 40 finishes 1C core option	ML ML 17 functions (M) 3 lever designs (ML) 2 lever designs (L) 4 finishes 1C core option (ML)	Q W ML L RL 17 functions (M) 7 functions (L) 3 lever designs (ML) 2 lever designs (L) 4 finishes 1C core option (ML)	T T T T 17 functions (M) 7 functions (L) 3 lever designs (ML) 2 lever designs (L) 4 finishes 1C core option (ML)	C C C C 17 functions (M) 7 functions (L) 3 lever designs (ML) 2 lever designs (L) 4 finishes 1C core option (ML)	D D D D 7 functions (M) 3 lever designs (ML) 2 lever designs (L) 4 finishes 1C core option (ML)	DC DC DC DC 5 finishes 1C core option	IL IL IL IL 3 finishes 1C core option	AL AL AL AL 3 finishes 1C core option	ED ED ED ED 4 finishes 1C core option

THE RIGHT PRODUCT OPTIONS FOR SECURITY PROFESSIONALS.

At Arrow, we're committed to provide the right products and tools to security professionals. That's why we developed such a wide variety of product options in three separate categories. With our Premier, Classic and Value product lines, we make it easy for you to find the right solution for every customer that walks through your door at a price that matches their budget. This level of expertise and service is something that other retailers can't provide. Arrow wants to be more than a supplier to security professionals — we want to be a security partner. To learn more about the benefits of selling Arrow, call us at 800-839-3157 or visit us online at www.arrowlock.com.



ASSA ABLOY, The global leader in door opening solutions

ASSA ABLOY

Arrow Lock Product Matrix.....2

About Arrow Lock.....5

Finishes6

Limited Warranty.....7

Terms & Condition of Sale9

Keys & Cylinders.....15

 Pointe Flex.....16

 Pointe.....17

 Cylinder Housings18

 Cams and Tailpieces.....19

 Cylinders20

Mortise Locks.....21

 AM & BM Series22

Cylindrical Levers.....37

 Q Series38

 W Series46

 ML Series.....52

 L Series.....59

 RL Series.....63

Tubular Locks.....67

 C Series.....68

Cylindrical Knobs73

 H&S Series.....74

 MK Series82

 RK Series88

Deadbolts.....93

 D Series94

 E Series96

 N Series98

Surface Door Closers101

 900N102

 5016N104

 DC200.....106

Interconnected Locks.....107

 JL Series Interconnected Lock108

Alarmed Hardware.....111

 100 & 300 Series.....112

 400 Series.....113

Exit Devices115

 3000 Series116

 4000 Series118

 S1150 & S1250 Series.....119

 1700, 1800, & 1900 Series122

 500 & 600 Series.....124

2008 Product Catalog

ASSA ABLOY, the global leader
in door opening solutions



ASSA ABLOY

THE RIGHT PRODUCTS

	SFIC	MORTISE LOCKS	CYLINDRICAL LEVERS	TUBULAR LOCKS	CYLINDRICAL KNOBS
PREMIER	Pointe Flex	AM/BM	Q W ML L RL	C	H S MK RK
	Patented key design Lockout feature Solid brass construction Reinforced sleeve design	GRADE 1 29 functions 15 knob designs 21 lever designs 8 finishes	GRADE 1 17 functions (Q) 16 functions (W) 3 lever designs 6 finishes Overdrive option IC core option		GRADE 1 20 functions (H) 13 functions (S) 4 designs (H) 2 designs (S) 8 finishes (H) 2 finishes (S) IC core options
CLASSIC	Pointe	AM/BM	Q W ML L RL	C	H S MK RK
	Solid brass construction Reinforced sleeve design		GRADE 2 17 functions (ML) 7 functions (L) 3 lever designs (ML) 2 lever design (L) 6 finishes Overdrive option (ML) IC core option (ML)		GRADE 2 17 functions 6 designs 7 finishes IC core option
VALUE		AM/BM	Q W ML L RL	C	H S MK RK
			Grade 2 7 functions 2 lever designs 6 finishes IC core option	Grade 2 6 functions 4 lever designs 3 knob designs 5 finishes	Grade 2 6 functions 1 designs 6 finishes IC core option

2008 Product Catalog

ASSA ABLOY, the global leader
in door opening solutions





DEADBOLTS	DOOR CLOSERS	INTER-CONNECTED LOCKS	ALARMED HARDWARE	EXIT DEVICES
-----------	--------------	-----------------------	------------------	--------------

D E	900N 5016N	JL	100 300 400	500 1000 3000 4000 1700
<p>GRADE 1</p> <p>7 functions</p> <p>7 finishes</p> <p>IC core options</p>	<p>GRADE 1</p> <p>Standard or hold open</p> <p>5 finishes</p>		<p>GRADE 1</p> <p>3 finishes</p> <p>4 hardware finishes</p> <p>3 versions:</p> <p>Stand alone (100)</p> <p>Paddle (300)</p> <p>Touchbar (400)</p>	<p>GRADE 1</p> <p>4 styles: mortise, rim, SVR, CVR (3000)</p> <p>3 styles: mortise, rim & SVR (4000)</p> <p>7 finishes (3000)</p> <p>6 finishes (4000)</p>

D E	900N 5016N	JL	100 300 400	500 1000 3000 4000 1700
<p>GRADE 2</p> <p>2 styles (41&61)</p> <p>6 functions (61)</p> <p>1 function (41)</p> <p>7 finishes</p> <p>IC core option (61)</p>		<p>GRADE 2</p> <p>4 functions</p> <p>3 lever designs</p> <p>7 finishes</p> <p>IC core option</p>		<p>GRADE 1</p> <p>2 styles: rim & SVR (1250)</p> <p>3 styles: mortise, rim & SVR (1700)</p> <p>4 finishes (1250)</p> <p>6 finishes (1700)</p>

D E	900N 5016N	JL	100 300 400	500 1000 3000 4000 1700
				<p>Grade 1</p> <p>2 styles: rim & SVR</p> <p>2 finishes</p>

2008 Product Catalog

ASSA ABLOY, the global leader in door opening solutions





RIGHT PRODUCTS

	SFIC	MORTISE LOCKS	CYLINDRICAL LEVERS	TUBULAR LOCKS	CYLINDRICAL KNOBS	DEADBOLTS	DOOR CLOSERS	INTER-CONNECTED LOCKS	ALARMED HARDWARE	E-DEVICES
PREMIER	Points Plus	AM, BM	Q W ML RL	C	H S MK RK	D E	800N 8010N	JL	100 300 400 500 1000 2000 3000 4000	5000 6000
CLASSIC	Patented Key Design Patented Rotator Solid Brass Innovative Patented Key Design	GRADE 1 20 Functions 2.5 lever designs 2.1 lever designs 6 finishes Overdrive option IC core option	GRADE 2 17 Functions (ML) 7 Functions (RL) 3 lever designs (ML) 2 lever designs (RL) 6 finishes Overdrive option (ML) IC core option (ML)	GRADE 2 20 Functions (ML) 3.9 lever designs (ML) 4 lever designs (RL) 2 lever designs (S) 2 finishes (S) 2 finishes (M) 10 lever designs	GRADE 2 17 Functions (ML) 6 lever designs (RL) 1 function (H) 2 finishes IC core option (H)	GRADE 2 2 styles (41,601) 18 Functions (601) 1 function (H) 2 finishes IC core option (H)	GRADE 1 5 finishes 4 lever designs Stand alone (1201) Patented (602) Tri-Function (406)	GRADE 1 4 styles: mortise, rim, SVR, CV 3 styles: mortise, rim & SVR 7 finishes (2002) 6 finishes (400)	GRADE 1 2 styles: rim & SVR (1200) 3 styles: mortise, rim & SVR (1700) 6 finishes (1220) 6 finishes (1700)	
VALUE		AM, BM	Q W ML RL	C	H S MK RK	D E	800N 8010N	JL	100 300 400 500 1000 2000 3000 4000 5000	
			Grade 2 7 functions 2 lever designs 6 finishes IC core option	Grade 2 6 functions 4 lever designs 3 knob designs 5 finishes	Grade 2 6 functions 1 design 6 finishes IC core option	Grade 2 6 functions 1 design 6 finishes IC core option		Grade 1 2 styles: rim & SVR 2 finishes		

CYLINDRICAL LEVERS

Q ML RL

PREMIER
GRADE 1
 17 functions
 3 lever designs • 6 finishes
 Overdrive option • IC core option

Q ML RL

CLASSIC
GRADE 2
 17 functions
 3 lever designs • 6 finishes
 Overdrive option • IC core option

Q ML RL

VALUE
 Grade 2
 7 functions • 2 lever designs
 6 finishes • IC core option

THE RIGHT CYLINDRICAL LOCKS FOR SECURITY PROFESSIONALS.

Arrow's commitment to the locksmith channel is based around providing the right products and tools for Security Professionals. We provide a range of cylindrical locks in our Premier, Classic and Value line. This will allow your customers to have the Right product choice to meet their price point and application. To learn more about the benefits of selling Arrow, please call us at 800-839-3157 or visit us online at www.arrowlock.com.

ASSA ABLOY, The global leader in door opening solutions



Since 1949, Arrow has been recognized as a leading supplier of locking hardware, door controls and key systems. Our ability to provide a full range of security products gives the security professional a clear advantage for retrofitting a variety of applications. As part of the ASSA ABLOY group, the world's leading lock group, we are uniquely positioned as the single source for commercial and residential projects ranging from expansive commercial and institutional facilities to single family dwellings. Arrow products are available nationwide through a network of authorized distributors.

The Arrow Lock Edge

Value

When you select Arrow products as a standard for your application, you will be adding value to your customers. Our complete line of door hardware satisfies the requirements of most door openings, allowing end users to achieve maximum security and design continuity while taking budget considerations into account.

Advantage

The ability to offer a full range of products supplied by one supplier will give you the competitive advantage you need. The Arrow advantage is just that, locks, exit devices and door closers, combined with the most extensive range of cylinder options available today.

Recognition

Arrow is recognized today as a leading manufacturer of door hardware. Arrow consistently turns out the highest quality products, all of which exceed the toughest internal as well as industry standards. Once installed, these products will function properly for years, even under the most rigorous conditions.

Product Catalog Guide

This product catalog has been designed to help you easily select Arrow products, at various price point and grade levels, depending upon the type of application being used. Should you require additional information, the name of a sales representative or authorized Arrow distributor, please phone 1-800-839-3157.

2008 Product Catalog

605 (US3)

Bright Brass

606 (US4)

Satin Brass

609 (US5A)

Satin Brass, Blackened

611 (US9)

Bright Bronze

612 (US10)

Satin Bronze

613 (US10B)

Oil Rubbed Satin Bronze

619 (US15)

Satin Nickel

625 (US26)

Bright Chromium Plated

626 (US26D)

Satin Chromium Plated

629 (US32)

Bright Stainless Steel

630 (US32D)

Satin Stainless Steel

689 (US28)

Aluminum (AL)

690

Dark Bronze (DBZ), (BRZ)

691

Light Bronze (LBZ)

GOLD

(GL)

RED

(RD)

The finishes listed above represent a sampling of those most commonly used. Due to the different types of base metals used in the manufacture of our products, finishes may vary slightly.

We strongly urge that when specifying or selecting finishes, careful consideration be given to opening usage requirements and climatic conditions. These factors may over time cause a breakdown to protective coatings or damage metal finishes.

* For availability of non-standard finishes, please consult Arrow customer service, an Arrow sales representative or your authorized Arrow distributor.

Interchangeable Core 

Look for this symbol to indicate availability of product with interchangeable core.

ADA/Americans with Disabilities Act 

Acceptable Door Hardware: Section 4.13.9

“Handles, pulls, latches and other operating devices on accessible doors shall have a shape that is easy to grasp with one hand and does not require grasping, tight pinching or twisting of the wrist to operate. Lever operated mechanisms, push-type mechanisms and “U” shaped handles are acceptable designs. Hardware for accessible door passage shall be mounted no higher than 48 inches (1219.20mm) above the finished floor.”

Look for the universal symbol next to Arrow products that comply with ADA Accessibility requirements.

ARROW LOCK® warrants that its products sold under the “ARROW LOCK” trade name in the United States of America are free from defects in workmanship and materials under normal use and service.

This warranty does not cover defects or damage arising from improper installation, lack of or improper maintenance, improper storage, shipping and handling, corrosion, erosion, ordinary wear and tear, misuse, abuse, accident, unauthorized service, or use with unauthorized non-ARROW LOCK products or parts.

This warranty is void if any modification is made to the warranty product, regardless of whether the modification causes or contributes to the alleged defect. All modifications are made at the risk of the party making the modification.

The only liability of ARROW LOCK®, in tort or contract whether under this warranty or otherwise, shall be limited to the repair or replacement of any product or component part which shall prove defective as covered by this warranty, within the stated time period listed below, after delivery to the original purchaser.

- AM & BM Series Mortise Locks – 5 years
- Q, W, & ML Series Cylindrical Locks – 3 years
- 1150 & 1250 Series Exit Devices – 3 years
- 3000 & 4000 Series Exit Devices – 5 years
- Door Closers – 10 years
- CK & CL Series Tubular Locks – 5 years
- RK & RL Series Cylindrical Locks – 5 years
- All other ARROW LOCK products – 1 year

Warranty for Cylinders Factory or Field Combined

Cylinders shall be periodically lubricated depending on environmental conditions. Dry graphite, molybdenum disulfide, or Polyube® are recommended. Petroleum based liquid lubricants should only be used in cylinders in harsh or corrosive environments and should not be mixed with dry lubricants.

Warranty for Cylinders Field Combined

1. Keys shall be cut to the ARROW LOCK® key biting specifications required for the particular keyway and depth system.
2. All pin lengths shall be selected according to prevailing factory standards.
3. Original ARROW LOCK® cylinder components, including pin tumblers and key blanks, shall be used. We reserve the right to void the warranty if we deem that a malfunction is a result of non-original components which do not conform to ARROW LOCK® standards.

Keying Systems

All bittings shall be originated or authorized by the ARROW LOCK® Key Systems Department to be compatible with one another in a specific type of cylinder (conventional, security, high security, interchangeable core, removable core) and within a particular keying system.

ARROW LOCK® will not pay for the cost of repair performed other than in accordance with this warranty.

Refer to our Returned Goods Policy regarding the return of a product or component part believed to be defective as covered by this warranty. A brief description of the defect will be required. Product will be examined upon return. In the event such examination reveals a defect covered by this warranty, the product will be repaired or replaced.

THIS WARRANTY IS IN LIEU OF ALL OTHER EXPRESS WARRANTIES. TO THE EXTENT PERMITTED BY LAW, ALL IMPLIED WARRANTIES ARE LIMITED TO THE DURATION OF THIS WARRANTY. ARROW LOCK® MANUFACTURING COMPANY SHALL NOT BE LIABLE FOR ANY INCIDENTAL OR CONSEQUENTIAL DAMAGES. NO AGENT, SALES REPRESENTATIVE OR DEALER HAS THE AUTHORITY TO INCREASE OR ALTER THE OBLIGATIONS OF THIS WARRANTY.

SOME STATE DO NOT ALLOW LIMITATIONS ON HOW LONG AN IMPLIED WARRANTY LASTS OR THE EXCLUSION OR LIMITATION OF INCIDENTAL OR CONSEQUENTIAL DAMAGES, SO THE ABOVE LIMITATIONS OR EXCLUSIONS MAY NOT APPLY TO YOU.

THIS WARRANTY GIVES YOU SPECIFIC LEGAL RIGHTS, AND YOU MAY ALSO HAVE OTHER RIGHTS WHICH VARY FROM STATE TO STATE.

ARROW LOCK® Manufacturing Company

Acceptance

ARROW LOCK® reserves the right to decline an order, in whole or in part, when the type or quantity of goods or credit worthiness of the Purchaser is not satisfactory to us in our sole and absolute discretion.

Purchase Orders, Quote requests, Acknowledgements or the like issued by the Purchaser that have contrary standard terms and conditions are not binding on ARROW LOCK®, unless such terms and conditions are approved in a separate written agreement by ARROW LOCK's authorized representatives. In the event of an acceptance of Purchaser's Purchase Order by ARROW LOCK®, the Purchaser agrees that such acceptance is solely conditioned on Purchaser's acceptance of the terms and conditions set forth in this instrument, regardless of the terms and conditions specified in the Purchaser's Purchase order. The terms and conditions in Purchaser's Purchase order which conflict with terms and conditions of this instrument shall be disregarded and are hereby rejected, and this instrument shall constitute the entire agreement between ARROW LOCK® and the Purchaser.

In the event that ARROW LOCK® does not enforce or require strict performance of any term or condition hereof, or of any other document, instrument or other agreement relating to goods sold, such lack of enforcement or requirement of strict performance will not waive, affect or diminish any right of ARROW LOCK® to enforce or require strict performance of such term or condition in the future.

Prices

All prices are subject to change without notice and are not guaranteed. All shipments will be made at prices in effect at the time of order acceptance.

Possession of this price list does not constitute an agreement to sell.

We reserve the right to correct clerical, stenographic and other obvious errors at any time.

Terms

2% 10 net 30 days after statement date.

It is understood that ARROW LOCK® may impose and charge a finance charge which is the lesser or one and one-half percent (1-1/2%) per month or the highest rate allowed by law on any amount which becomes past due and delinquent. Additionally the Customer shall be responsible for all collection costs, court costs and reasonable attorney's fees (where allowed by law) in connection with the recovery of any delinquent amount.

Freight

All orders are shipped FOB factory/warehouse, except as expressly provided below. When delivered to the Transportation Company, the Purchaser assumes the risk of loss or damage in transit.

Customer orders with net product value in excess of **\$5,000.00** will be shipped prepaid to a single destination point in the United States.

Customer order with net product value less than **\$5,000.00** will be shipped prepaid by ARROW LOCK's carrier of choice, and the shipping charges will be added to Customer's invoice. ARROW LOCK® will choose the carrier and routing. If a Customer requests an alternative carrier, freight charges will be incurred on Customer's invoice.

Great Grand Master keys, Grand Master keys, Master keys, Construction Master keys, Control Keys, which are shipped separate from customer order, for security reasons, with net product value less than **\$5,000.00** will be shipped prepaid by ARROW LOCK's carrier of choice, and the shipping charges will be added to Customer's invoice.

Minimum Invoice

Minimum invoice for complete product is \$200.00 net product value. The minimum invoice for parts orders is \$100.00 net product value.

This policy does not include the following: Cut (bitted) Keys of any type, Master Keyed Cylinders, Master Keyed Padlocks and Factory Generated Bitting Lists.

Same day order expedites will be invoiced at book net.

Quotations

If ARROW LOCK® elects to offer a Quote; such Quote will be valid for sixty (60) days. Complete shipment of the order must be accepted by Purchaser within nine (9) calendar months from the date of price issuance.

The Quote number must be referenced on the order.

Any invoiced order that has the incorrect discount applied to it and did not have a Quote copy attached to the order or the Quote number written on the order will have a service fee of \$75.00 net DEDUCTED from any sales credit issued for the difference in discount.

The Quote is null and void if the Purchase Order does not include **ALL** product lines listed on the Quote or if the quantities for an item covered by the Quote deviate by **10%** or more.

With the issuance and acceptance of a Quote for the purchase of products, the Purchaser agrees that products so purchased will not be resold or transferred to any Distributor not authorized by ARROW LOCK® to sell its products. This would be inclusive of branches of the quoted Distributor. Failure to abide by this restriction may result in the Distributor's ineligibility for Price Concession Authorizations, or other actions in ARROW LOCK's discretion.

ARROW LOCK® and its sales representatives reserve the right, in their sole discretion and for any reason, to refuse a Distributor's request to quote a price other than ARROW LOCK's standard list price and regardless of whether ARROW LOCK® or its sales representatives have previously quoted discounted prices to the Distributor on some or all of its orders.

Non-Cataloged Products

Products not cataloged or listed in this price book will be considered as special products, and will not be manufactured without prior approval from ARROW LOCK®.

A minimum special handling charge of **\$50.00** will be added for non-cataloged product. Any additional labor or material required will be charged accordingly.

Special products require special handling, and therefore standard lead times may not apply. Please consult with your Sales Representative for further details.

Changes / Cancellation of Orders

Changes or cancellations to an order will result in a charge of costs for material and labor expenses that have been incurred prior to notification from Customer. Handling charges are billed on Customer's original order.

All Non-Cataloged Goods and ARROW LOCK® Arrow Express Orders may not be changed or cancelled.

All change requests for goods, other than for the two reasons stated above, must be submitted in writing to Customer Service within two (2) business days of receipt of acknowledgement of the order.

Add-On Orders to Quote

Any new order requesting special pricing to match an existing Quote number, which has already been ordered, will be accepted up to 60 days after the acknowledgement of the original order. All add-on orders must reference the original factory order number and the corresponding Quote number to receive the quoted pricing discount. Add-on orders for stock will not be accepted.

Delivery

Orders will be acknowledged and given a scheduled delivery date based on estimated manufacturing lead times. Complete information is required to process all orders. Orders with insufficient information for processing (i.e. keying information, door sizes, etc.) may be subject to extended lead times which are relative to the time required in obtaining the necessary information for order processing. Manufacturing lead time will begin once all information is received to process an order. ARROW LOCK® will use reasonable efforts to deliver products as estimated, but makes no guarantees as to delivery dates.

ARROW LOCK® will not be liable for back charges incurred based on availability of product or as a result of delays in delivery caused by insufficient information required to process an order.

ARROW LOCK® will not be held responsible for delays in delivery caused by strikes, fires, floods or any other causes beyond our control, including the delivery of material to us. Under no circumstances shall ARROW LOCK® be liable or accountable for consequential damages due to failure of delivery.

Claims

In the event of Company or Customer error, claims for shortages, pricing errors and/or incorrectly filled orders must be submitted in writing to Customer Service within thirty (30) days from receipt of material.

Any claims for shortages or damage by the Carrier must be made by the Customer directly to the Carrier.

Limited Carrier insurance is typically offered for all orders. If the Customer requires additional insurance, please contact an ARROW LOCK® Customer Service Representative upon submittal of the order. ARROW LOCK® will obtain requested insurance and the additional cost will be included on Customer's invoice.

Invoice Deduction

An ARROW LOCK® Sales Representative or Customer Service Representative must be notified of any disputed invoices within sixty (60) days from the date of invoice. Deductions should only be taken for the disputed amount and the balance of the invoice is due and payable within standard payment terms.

Returned Goods

It is the policy of ARROW LOCK® to **not** accept returns of any materials that are correctly furnished as per the Distributor's Purchase Order. Return of product due to customer order error or accommodation must be pre-arranged with ARROW LOCK® and approved in writing by Sales Management.

All products returned as "Goodwill" must meet the following criteria to be considered a return:

- Be in original, unmarked, and undamaged cartons.
- Be valued in excess of \$200.00 net.
- Shipped and invoiced within the previous 120 days.
- Custom, non-cataloged goods, master-keyed or ARROW LOCK® Arrow Express shipped product is not returnable.

A **MINIMUM** restocking fee of **30%** will be charged. Upon receipt and verification by ARROW LOCK® that the returned merchandise meets the foregoing conditions, a credit will be issued for the original invoice amount less the **MINIMUM 30%** restocking fee.

Defective goods and "Goodwill" products that meet the foregoing criteria may be returned by fulfilling the following conditions:

- Send an RGO request in writing to the ARROW LOCK® Sales Representative serving the Purchaser's area.
- Ensure the RGO labels that are sent to Purchaser by ARROW LOCK® are visible on return goods shipment.

- Ensure that the RGO number appears on the return shipment label and is legible.
- Return the authorized merchandise within sixty (60) days from the date of RGO issuance date.
- Return shipments must be freight prepaid to the location specified on the RGO.
- ARROW LOCK® is not liable for damages to product during shipping.

No credit may be taken or issued prior to RGO approval and receipt of product.

All defective goods within the terms of our limited warranty may be returned for credit or replacement.

Taxes

Prices do not include any present or future Federal, State, or Local property, license, privilege, sales, use, and excise, gross receipts or other like taxes or assessments, which may result from transactions or any services performed in connection herewith.

Governing Law

The rights and obligations of the parties shall be governed by the laws of the State of New York, excluding any conflicts of law provisions. The United Nations Convention on Contracts for the International Sale of Goods shall not apply to this Agreement.

Limited Warranty

The Terms and Conditions outlined above are subject to ARROW LOCK® Limited Warranty, which is included in this Price List and incorporated herein by reference.

Product Modifications

ARROW LOCK products are not designed for or intended for aftermarket modification. The warranty on ARROW LOCK products becomes void if the product is modified in any way, regardless of whether the modification causes or contributes to any alleged defect. Warranty voiding modifications include, but are not limited to, third-party electrification of non-electric products and/or the installation of non-approved or non-ARROW LOCK components.

If an ARROW LOCK product is modified it no longer meets industry certification and quality control standards applicable to the original product and is no longer a genuine ARROW LOCK product. A modified product may not be sold as an ARROW LOCK product and no ARROW LOCK trademarks or certification marks based on the original ARROW LOCK product, such as U.L. or ANSI/BHMA marks, may appear anywhere on the modified product or on any packaging, literature or instructions sold with the modified product.

All original ARROW LOCK packaging and literature carrying ARROW LOCK trademarks must be destroyed if the original ARROW LOCK product is modified. Portions of the product that carry an ARROW LOCK trademark or certification mark, such as mortise faceplates, lock bodies, etc. must be discarded and/or replaced by the party making the modification. U.L. and other certification testing and marking are also the responsibility of the party making modification. The use of ARROW LOCK trademarks on modified products constitutes trademark infringement.

Individual Components

It is company policy that components including but not limited to latches sold separate from locksets are intended to be sold as replacement components for appropriate ARROW LOCK products only. All other uses require prior written approval from ARROW LOCK.

Trademarks

ARROW LOCK® is a registered trademark of ARROW LOCK Manufacturing Company.

Other product brand names may be trademarks or registered trademarks of their respective owners and are mentioned for reference purposes only.



LIGHT PRODUCTS											
SPIC	MORTISE LOCKS	CYLINDRICAL LEVERS	TUBULAR LOCKS	CYLINDRICAL KNOBS	DEADBOLTS	DOOR CLOSERS	INTER-CONNECTED LOCKS	ALARMED HARDWARE	IC DEVICES		
AM/BM	Q W RL L RL	C	H S MK RK	D E	900N 5016N	JL	100 300 400	500 1000 3000 4000	500 1000 3000 4000	500 1000 3000 4000	500 1000 3000 4000
<p>Grade 1 20 Functions</p> <p>Grade 2 10 knob designs 20 lever designs 8 finishes</p>	<p>Grade 1 17 Functions (M)</p> <p>Grade 2 10 knob designs (M) 20 lever designs 8 finishes</p> <p>Operative options IC core option</p>	<p>Grade 1 20 Functions (M)</p> <p>Grade 2 10 knob designs (M) 20 lever designs 8 finishes</p> <p>Operative options IC core option</p>	<p>Grade 1 20 Functions (M)</p> <p>Grade 2 10 knob designs (M) 20 lever designs 8 finishes</p> <p>Operative options IC core option</p>	<p>Grade 1 20 Functions (M)</p> <p>Grade 2 10 knob designs (M) 20 lever designs 8 finishes</p> <p>Operative options IC core option</p>	<p>Grade 1 20 Functions (M)</p> <p>Grade 2 10 knob designs (M) 20 lever designs 8 finishes</p> <p>Operative options IC core option</p>	<p>Grade 1 20 Functions (M)</p> <p>Grade 2 10 knob designs (M) 20 lever designs 8 finishes</p> <p>Operative options IC core option</p>	<p>Grade 1 20 Functions (M)</p> <p>Grade 2 10 knob designs (M) 20 lever designs 8 finishes</p> <p>Operative options IC core option</p>	<p>Grade 1 20 Functions (M)</p> <p>Grade 2 10 knob designs (M) 20 lever designs 8 finishes</p> <p>Operative options IC core option</p>	<p>Grade 1 20 Functions (M)</p> <p>Grade 2 10 knob designs (M) 20 lever designs 8 finishes</p> <p>Operative options IC core option</p>	<p>Grade 1 20 Functions (M)</p> <p>Grade 2 10 knob designs (M) 20 lever designs 8 finishes</p> <p>Operative options IC core option</p>	<p>Grade 1 20 Functions (M)</p> <p>Grade 2 10 knob designs (M) 20 lever designs 8 finishes</p> <p>Operative options IC core option</p>
<p>CLASSIC</p> <p>AM/BM Q W RL L RL C H S MK RK D E 900N 5016N JL 100 300 400 500 1000 3000 4000 500 1000 3000 4000</p> <p>Grade 1 20 Functions (M)</p> <p>Grade 2 10 knob designs (M) 20 lever designs (M) 8 finishes</p> <p>Operative options (M) IC core option (M)</p>											
<p>VALUE</p> <p>AM/BM Q W RL L RL C H S MK RK D E 900N 5016N JL 100 300 400 500 1000 3000 4000 500 1000 3000 4000</p> <p>Grade 1 7 Functions</p> <p>Grade 2 6 Functions</p> <p>2 lever designs 3 knob designs 3 finishes IC core option</p>											

Cylinders and IC Products

Pointe, Pointe Flex

ASSA ABLOY, the global leader in door opening solutions



The Pointe Flex System offers a totally new concept in interchangeable core key control. The system employs a unique core security feature and patented key design. The unique feature is the pin assembly which runs through the center of the core keyway preventing standard competitive interchangeable core keys from entering the lock cylinder. Only the patented Pointe Flex key can operate locks with the Pointe Flex cylinder. All keyways are restricted and will be issued on a contractual basis, determined by geographical availability. Pointe Flex enables you to create a high/low system, by incorporating core with and without the pin assembly, greatly enhancing flexibility.



7 PIN INTERCHANGEABLE CORE & PATENTED KEY

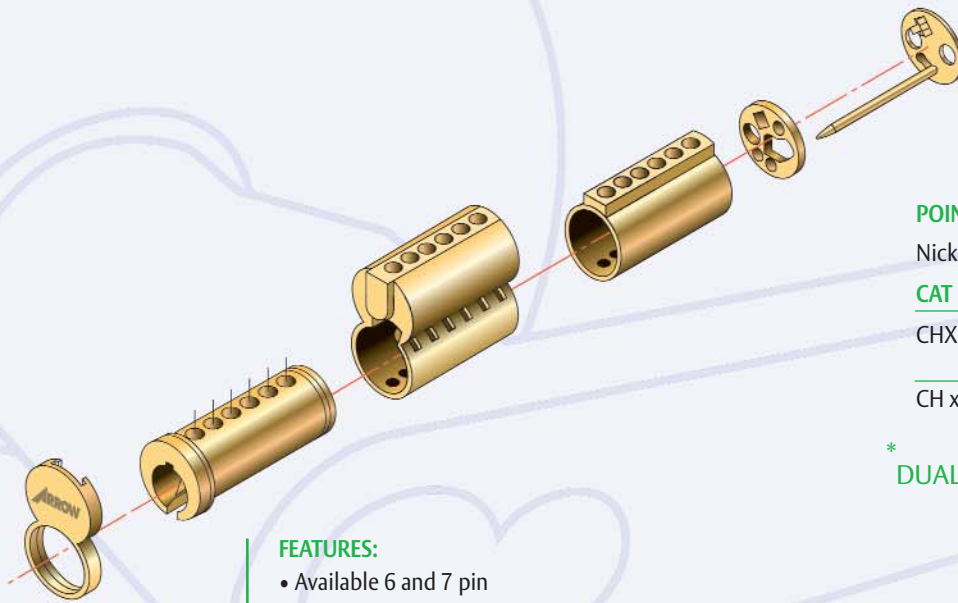

FEATURES:

- Available 6 and 7 pin
- Solid brass construction
- Reinforced sleeve design
- Combined or Uncombined
- US26D or US4 finish

ARROW KEYWAYS:

Restricted keyways—consult factory for availability.

CAT NO.	DESCRIPTION
X1CR	6 Pin Core Combined
X71CR	7 Pin Core Combined
X1CR-UC	6 Pin Core Uncombined
X71CR-UC	7 Pin Core Uncombined

POINTE FLEX KEY BLANKS

Nickel Silver

CAT NO.	DESCRIPTION
CHX x Keyway	6 or 7 Pin Key Blank, with hole in blade
CH x Keyway	6 or 7 Pin Key Blank without hole in blade

*** DUALEVEL MASTERKEYING CAPABILITIES.**

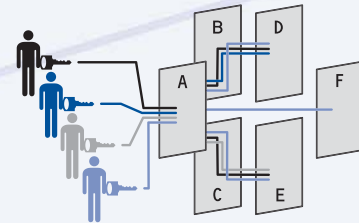

† Door "F" uses Flexcore within masterkey system.

- Maintenance (A, B, C, D, E)
- Supervisor A (A, B, D)
- Supervisor B (A, C, E)
- General Manager (All doors)†

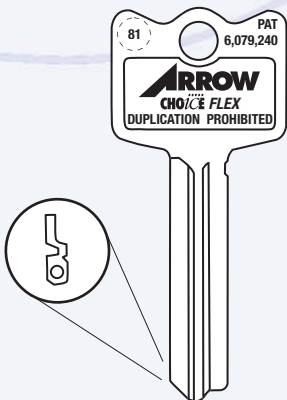

Arrow Pointe interchangeable core products offer dealers unlimited flexibility and keying options. Available in standard 6 and 7 pin format in Arrow and competitive keyways, dealers can install Arrow Pointe in new or existing key systems. Arrow's unique manufacturing process gives Arrow Pointe interchangeable cores unmatched strength and durability. The core features four main components: The plug, shell, sleeve and faceplate. Our precision engineering design, keying capability and availability make Arrow Pointe interchangeable cores our most specified brand for commercial, industrial and institutional applications.

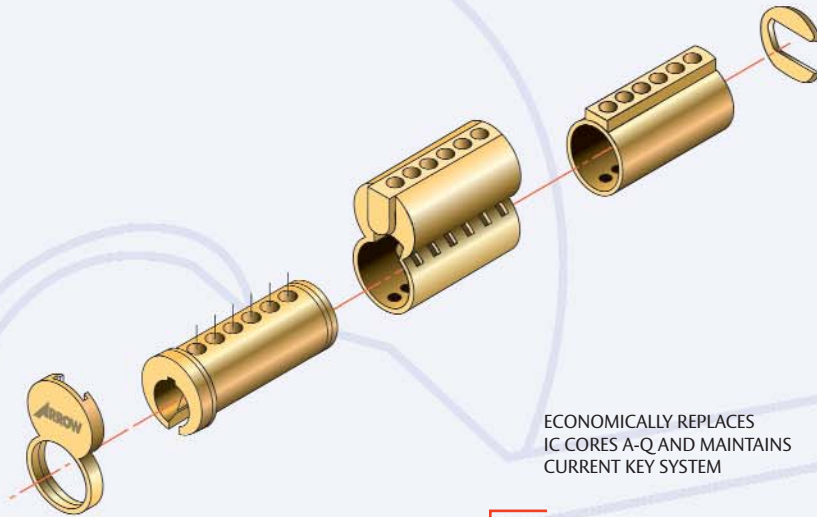

ECONOMICALLY REPLACES IC CORES A-Q AND MAINTAINS CURRENT KEY SYSTEM

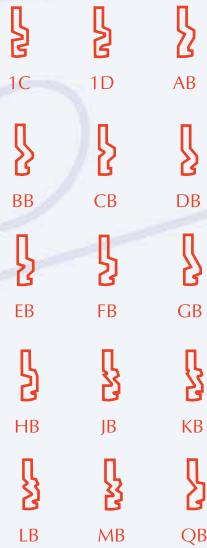
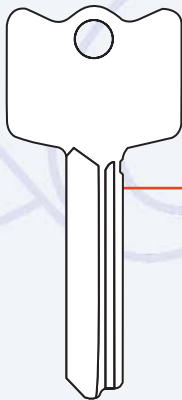

7 PIN INTERCHANGEABLE CORE

6 PIN INTERCHANGEABLE CORE

POINTE KEY BLANKS

Nickel Silver

CAT NO.	DESCRIPTION
C x Keyway	6 or 7 Pin Key Blank
CP x Keyway	6 or 7 Pin Key Blank, Plain Bow

FEATURES:

- Solid Brass Construction
- Reinforced Sleeve Design
- Combined or Uncombined
- US26D or US4 finish

ARROW KEYWAYS:

1C & 1D Standard keyways or restricted keyways—consult factory for availability.

COMPETITIVE KEYWAYS:

AB, BB, CB, DB, EB, FB, GB, HB, JB, KB, LB, MB, QB

CAT NO.	DESCRIPTION
100CR	6 Pin Core Combined
7100CR	7 Pin Core Combined
100CR-UC	6 Pin Core Uncombined
7100CR-UC	7 Pin Core Uncombined

Cylinders and IC Products

ASSA ABLOY, the global leader in door opening solutions



ASSA ABLOY

Mortise Cylinder Housings

- Body-Brass, 1-5/32" diameter
- Furnished-with cam, cylinder collar
- Length-1-1/8" 6 pin only; 1-1/4" 6 or 7 pin

Mortise Cylinder Housing



16CR-16x (Cam)

Tapered Mortise Cylinder Housing



16CRT-16xAR18

Rim Cylinder Housing



16RCR-16

Rear Staked on Cam



16CR-16xAM2

Rim Cylinder Housing

- Body-Brass, 1-5/32" diameter; 6 or 7 pin tumbler
- Furnished-with backplate, cylinder collar 2 screws, tailpiece

IC Housings

Mortise Housings

Description (16CR-001 cam supplied unless otherwise specified)		Part No.
6-pin housings, 1-1/8"	Standard	16CR-16X (cam)
	Tapered	16CRT-16XAR18
	Hotel (1-1/4")	16CRH-16XAM2
7-pin housings, 1-1/4"	Standard	16CR-27X (cam)
	Tapered	16CRT-27XAR18

Rim Housings

Cylinders	Part No.
6-pin housing	16RCR-16
7-pin housing	16RCR-27



Front CholCe Plus Housing
C16CR-27x (Cam)



Rear CholCe Plus Housing Screw-on Cam
C16CR-27x001

Choice Plus Housings

Mortise Housings

Description (001 cam supplied unless otherwise specified)		Part No.
6-pin housings, 1-1/8"	Standard	C16CR-16X (cam)
	Tapered	C16CRT-16XAR18
7-pin housings, 1-1/4"	Standard	C16CR-27X (cam)
	Tapered	C16CRT-27XAR18
6-pin housings, drill resistant, 1-1/8"	Standard	C16CR-16DX (cam)
	Tapered	C16CRT-16DAR18
7-pin housings, drill resistant, 1-1/4"	Standard	C16CR-27DX (cam)
	Tapered	C16CRT-27DAR18

Rim Housings

Cylinders	Part No.
6-pin housing	C16RCR-16
7-pin housing	C16RCR-27
6-pin housing, drill resistant	C16RCR-16D
7-pin housing, drill resistant	C16RCR-27D

Spacers

CAT NO.	DESCRIPTION
16CR-123-1	1/8" Spacer - Blocking Ring
16CR-123-2	1/4" Spacer - Blocking Ring
16CR-123-3	3/8" Spacer - Blocking Ring
16-113A	Cylinder Collar & Spring

1/8" Spacer



16CR-123-1

1/4" Spacer

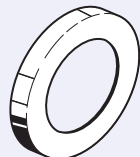

16CR-123-2

3/8" Spacer



16CR-123-3

Collar & Spring

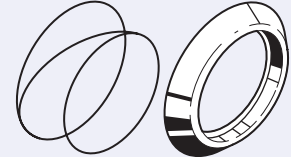

16-113A

Cams

- Staked cams for mortise cylinder housing for use with Pointe, CholCe Base, & CholCe Flex IC Cores

CAT NO.	FUNCTIONS & APPLICATION
16CR-001	12, 17, 22, 23, 24, 27, 32 I/S, 33, 37
16CR-AM2	11, 13, 15, 16, 19, 20, 21, 31, 32 O/S, 34, 41, 42, 44
16CR-004	N Series, Exit Device, Exit Alarms
16CR-006	Schlage
16CR-AR18	Adams Rite



- Screw on Cams for CholCe Plus IC Housings

CAT NO.	FUNCTIONS & APPLICATION
001	12, 17, 22, 23, 24, 27, 32 I/S, 33, 37
AM2	11, 13, 15, 16, 19, 20, 21, 31, 32 O/S, 34, 41, 42, 44
004	N Series, Exit Device, Exit Alarms
006	Schlage
AR18	Adams Rite



Tailpieces

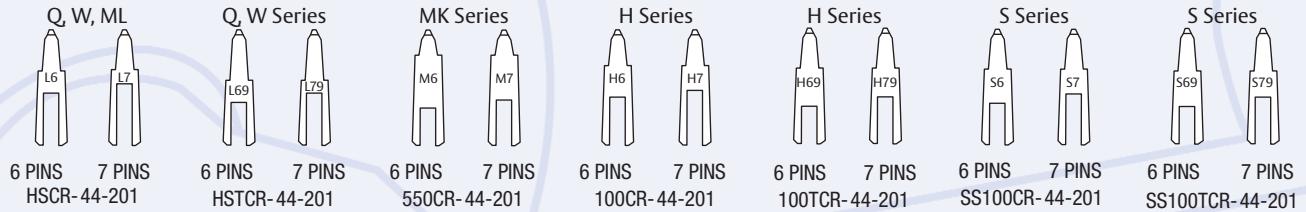

- For CholCe Base, Pointe, CholCe Flex IC cores

CAT NO.	DESCRIPTION
HSCR-44-201	Q, W, & ML Series (Except 19 & 15 Functions)
HSTCR-44-201	Q & W Series (19 Function only)
550CR-44-201	MK Series
100CR-44-201	H Series (Except 19 & 15 Functions)
100TCR-44-201	H Series (19 Function only)
HS100CR-44-201	S Series (Except 19 & 15 Functions)
HS100TCR-44-201	S Series (19 Function only)

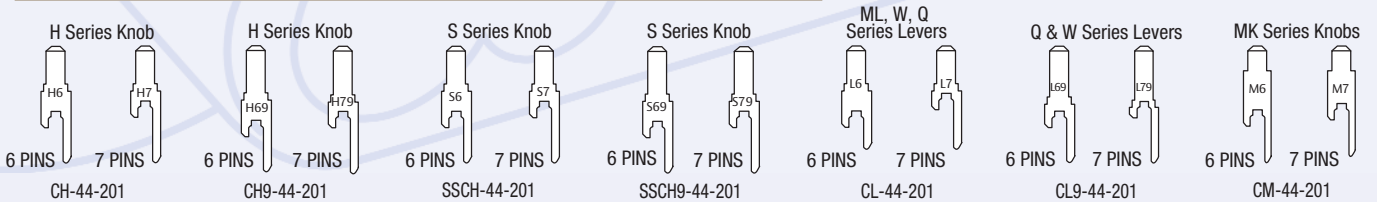

- Tailpieces for use with CholCe Plus IC cores only

CAT NO.	DESCRIPTION
CH-44-201	H Series Knob - 6, 7 pin (Except 15 & 19 Functions)
CH9-44-201	H Series Knob - 6, 7 pin (19 Function only)
SSCH-44-201	S Series Knob - 6, 7 pin (Except 15 & 19 Functions)
SSCH9-44-201	S Series Knob - 6, 7 pin (19 Function only)
CL-44-201	ML, W, Q, Series levers - 6, 7 pin (Except 19 & 15 Functions)
CL9-44-201	Q & W Series levers - 6, 7 pin (19 & all Overdrive Functions)
CM-44-201	MK Series Knob - 6, 7 pin

Tailpiece is not required for 15 function
All 6 and 7 pin tailpieces sold together as kit

Mortise Cylinders



General Specifications

Body – Brass, 1-5/32" (29.37mm) diameter. Six pin tumbler cylinder.
Furnished – Standard with cylinder collar.
Length–1-1/8" (28.57mm), 1-1/4" (31.75mm), 1-1/2" (38mm), 2" (51mm)
Scalp – Brass, Bronze
Keyway – "A" keyway standard. Arrow sectional keyways available. Consult factory for competitive keyway availability.

Finish

US3, US4, US10, US10B, US26, US26D

Cylindrical Lock Cylinders



General Specifications

Body – Solid brass pin tumbler 6 chambers. Pinned 5 for Grade 2 Locksets. Pinned 6 for Grade 1 locksets and all hotel locksets.
Keyway – "A" keyway standard. Arrow sectional keyways available. Competitive keyways available.

Finish

US4, US26D

Rim Cylinders



General Specifications

Body – Brass, 1-5/32" (29.37mm) diameter. Six pin cylinder.
Furnished – With back plate, 2 Screws (2" door max.), tailpiece and cylinder collar.
Scalp – Brass, Bronze
Keyway – "A" keyway standard. Arrow sectional keyways available. Consult factory for competitive keyway availability.

Finish

US3, US4, US10, US10B, US26, US26D

Deadlock Cylinders

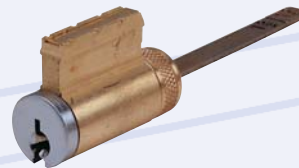

General Specifications

Body – Solid brass pin tumbler, 6 chambers for E & D series deadlocks. E series pinned 5. D series pinned 6.
Keyway – "A" keyway standard. Competitive keyways available.

Finish

US4, US26D

	LOCK	AM/BM	CK	CL	D	E	H	J	K	L	MK	ML	N	Q	RK	RL	S	W	Alarms	Exits
CYLINDER																				
MC61xCam		Std												Std					I/S	Std
96C (single cylinder)					Opt	Std		Std												
96DC (double cylinder)					Opt	Std														
692C (single cylinder)					Std	Opt		Opt												
692DC (double cylinder)					Std	Opt														
600HD							Std			Std		Std		Std		Std		Std		
S600HD																		Std		
100C			Std	Std							Std				Std					
RC62																			O/S	Std
RC63									Std											
C16CR-16/C16CR-27xCam		Std																	I/S	O/S
C16RCR-16/C16RCR-27																			O/S	I/S

Cylinders and IC Products

ASSA ABLOY, the global leader in door opening solutions



ASSA ABLOY



WEIGHT PRODUCTS										
	SFIC	MORTISE LOCKS	CYLINDRICAL LEVERS	TUBULAR LOCKS	CYLINDRICAL KNOBS	DEADBOLTS	DOOR CLOSERS	INTER-CONNECTED LOCKS	ALARMED HARDWARE	EXIT DEVICES
PREMIER	Pointe Flex	AM/BM	O W ML L RL	C	H S MK RK	D E	900N SOLEN	JL	100 300 400	1500 1600 3000 4000 1700
	Premier key design Lockset/Return Steel/Brass Cylindrical Reinforced Steel Design	GRADE 3 20 functions 10 lever designs 3 lever designs 4 finishes Overdrive option IC core option	GRADE 3 17 functions (M) 16 functions (ML) 3 lever designs 4 finishes Overdrive option IC core option	GRADE 3 20 functions (M) 18 functions (ML) 3 lever designs 4 finishes (M) 4 finishes (ML) 2 finishes (S) IC core option	GRADE 3 17 functions 7 finishes IC core systems	GRADE 3 20 functions (M) 18 functions (ML) 3 lever designs 4 finishes (M) 4 finishes (ML) 2 finishes (S) IC core option	GRADE 3 7 functions 7 finishes IC core systems	GRADE 3 standard or full open 9 finishes	GRADE 3 3 finishes 4 hardware finishes 3 variations Steel/Brass (1200) Powder (2000) Fourcolor (4000)	GRADE 3 4 styles: mortise, rim, SVR, DWR (2000) 3 styles: mortise, rim & SVR (4000) 7 finishes (2000) 6 finishes (4000)
CLASSIC	Pointe	AM/BM	O W ML L RL	C	H S MK RK	D E	900N SOLEN	JL	100 300 400	1500 1600 3000 4000 1700
	Steel/Brass construction Reinforced Steel Design	GRADE 2 17 functions (M) 7 functions (L) 3 lever designs (ML) 2 lever designs (L) 4 finishes Overdrive Option (ML) IC core option (ML)	GRADE 2 17 functions (M) 17 functions (ML) 6 designs 7 finishes IC core system	GRADE 2 17 functions (M) 16 functions (ML) 3 lever designs 4 finishes (M) 4 finishes (ML) 7 finishes IC core option (M) IC core option (ML)	GRADE 2 2 styles (L&R) 6 functions (M) 3 functions (ML) 7 finishes	GRADE 2 4 functions 3 lever designs 7 finishes IC core option	GRADE 2 4 functions 3 styles: mortise, rim & SVR (1200) 4 finishes (1250) 6 finishes (1700)	GRADE 2 2 styles: rim & SVR (1200) 3 styles: mortise, rim & SVR (1700) 4 finishes (1250) 6 finishes (1700)	GRADE 2 2 finishes	GRADE 2 2 finishes
VALUE		AM/BM	O W ML L RL	C	H S MK RK	D E	900N SOLEN	JL	100 300 400	500 1000 3000 4000 1700
		Grade 2 7 functions 2 lever designs 6 finishes IC core option	Grade 2 6 functions 4 lever designs 3 knob designs 5 finishes	Grade 2 6 functions 4 designs 5 finishes IC core option	Grade 2 6 functions 4 designs 5 finishes IC core option	Grade 2 4 functions 3 designs 5 finishes	Grade 2 4 functions 3 designs 5 finishes	Grade 2 2 finishes	Grade 2 2 finishes	Grade 2 2 finishes



Mortise Locks

AM/BM Series

ASSA ABLOY, the global leader in door opening solutions



Arrow mortise locks are intended for heavy duty use in schools, hospitals and commercial buildings where security, durability and low maintenance are required. They are engineered for strength and performance, and precisely manufactured to exacting standards.



Certification/Compliance

ANSI

Meets A156.13 Series 1000, Operational Grade 1.

Federal

Meets FF-H-106C, Series 86 and 87.

UL/ULC Positive Pressure

All locks listed for A Label and lesser class doors, 4" (122cm) x 10" (305cm) single or 8" (244cm) x 10" (305cm) pair. Letter F and UL symbol on armored front indicate listing. **California State**

Reference Code All levers with returns comply; levers return to within 1/2" (13mm) of door face.

Features

Handing—Handed; field reversible. The lockset can be re-handed without disassembling the lock case.

Door Thickness—1-3/4" (4mm) standard. Optional door thickness available; consult factory.

Backset—2-3/4" (70mm).

Lockcase—Heavy gauge steel, with zinc dichromate finish for corrosion resistance. 5-7/8" (149mm) x 4" (102mm) x 15/16" (24mm).

Armored Front—Heavy gauge steel, 8" (203 mm) x 1-1/4" (32mm) x 3/32" (2mm). Accommodates flat doors and doors beveled 1/8" (3mm) in 2" (51mm).

Faceplate—Wrought brass or bronze, attached by machine screws to lockcase front.

Latchbolt—Stainless steel, 2 piece mechanical with anti-friction insert. 5/8" (16mm) x 1" (25mm) x 3/4" (19mm) throw.

Auxiliary Latchbolt—9/16" (14mm) effective throw and 3/8" (10mm) effective auxiliary latch deadlocking.

Deadbolt—One-piece stainless steel, 19/32" (15mm) x 1 1/4" (32mm) x 1" (25mm) throw.

Hub—Knob: nickel steel, 5/16" (8mm) and 9/32". Lever: nickel steel, 5/16" (8mm).

Spacing—Center to center, hub to cylinder: 3-5/8" (92mm). Center to center, hub to turnpiece 2-7/16" (62 mm).

ADA/Americans with Disabilities Act

Acceptable Door Hardware: Section 4.13.9

Handles, pulls, latches and other operating devices on accessible doors shall have a shape that is easy to grasp with one hand and does not require grasping, tight pinching or twisting of the wrist to operate. Lever operated mechanisms, push-type mechanisms and "U" shaped handles are acceptable designs.



Look for the universal symbol next to Arrow products that comply with ADA accessibility requirements.

Strike—Wrought brass or bronze, ANSI straight lip standard, 4-7/8" (124mm) x 1-1/4" (32mm) 1-1/8" (29mm) lip to center. Optional strikes, lip lengths and ANSI wrought strike box available.

Keys—Two nickel silver standard.

Keying Features Available

- Master keying
- Construction master keying
- Visual key control
- Concealed key control
- Interchangeable core (IC) - Pointe, Choice Base, Plus, and Flex

Warranty Five-year limited.

Standardized Case—One size case for uniform mortising.

Reversibility—Locks are easily reversed for change of hand.

Self Aligning Trim—Standard with rose trim. Eliminates bind, facilitates installation, gives support and saves labor.

Designs—Broad spectrum of designs including lever handles, knobs for roses and escutcheons in architectural finishes.

Complete Range of Functions—To meet all requirements.

AM/BM Series Mortise Locks

Designs

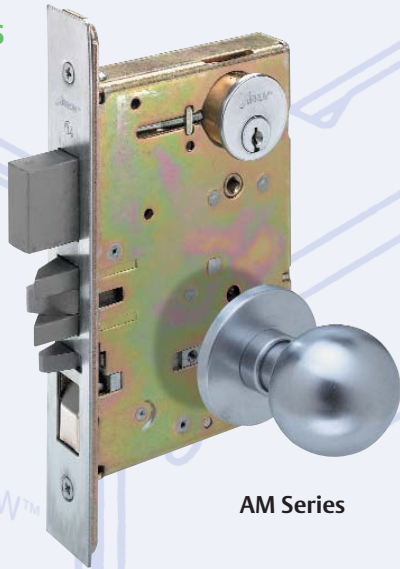

AM Series

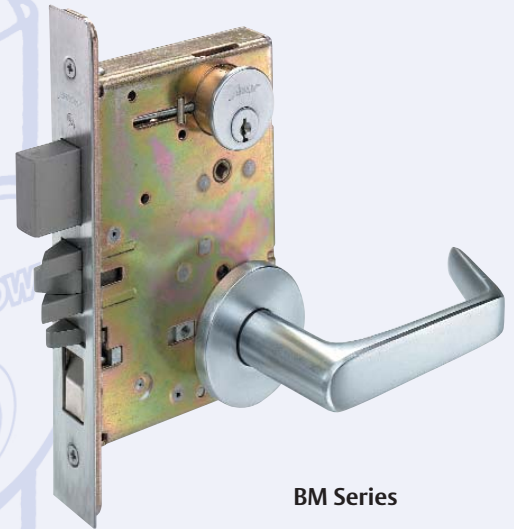

BM Series

Finishes



	BHMA	U.S. Equivalent	Arrow Equivalent	Finish
1	605	US3	03	Bright Brass
2	606	US4	04	Satin Brass
3	612	US10	10	Satin Bronze
4	613	US10B	10B	Dark Oxide Bronze, Oil Rubbed
5	625	US26	26	Bright Chromium Plated
6	626	US26D	26D	Satin Chromium Plated
7	629	US32	32	Bright Stainless Steel
8	630	US32D	32D	Satin Stainless Steel

Applications

Arrow mortise locks are offered in a complete range of functions designed for commercial, institutional and industrial applications. They are engineered for strength and performance, and precisely manufactured to exacting standards.

A wide selection of trim designs and functions are offered which meet or exceed the performance requirements of ANSI Grade 1.

Arrow mortise locks can be found in the following types of facilities:





- Schools
- Office Buildings Facilities
- Multi-Family Housing
- Hospitals
- Government

Advantages



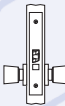
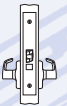
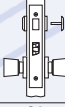
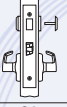
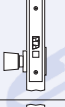
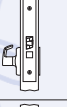
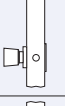
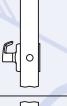
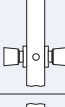
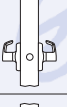
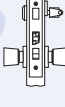

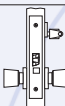
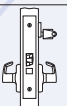
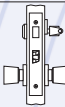
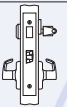
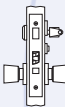
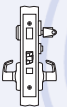





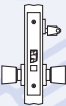

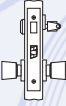
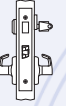
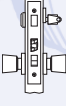

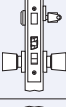
- Easily reversible, enabling the user to reverse hands without disassembling lock case
- Meets or exceeds ANSI operational Grade 1 requirements.
- Throughbolted trim designs for proper alignment and increased security.
- Many trim designs to complement Arrow cylindrical locks and exit device trims.
- Keyed into new or existing Arrow or competitive master key systems

* Note: Not all trim designs available in all finishes.

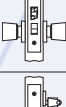
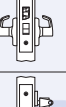
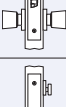
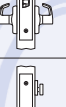
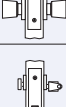





AM/BM Series Mortise Locks

ARROW	Function	ANSI/ Federal #	AM Series	BM Series	Description
01	Passage	F01/86N			Latchbolt by knob/lever either side
02	Privacy	F19/86L			Latchbolt by knob/lever either side, except when outside is locked by turnpiece inside. Outside emergency release or operating from inside unlocks lock. Inside knob/lever retracts both bolts.
07	Exit				Latchbolt by knob/lever inside. Auxiliary latchbolt deadlocks latchbolt. No outside trim.
08	Single Dummy Trim				Rigid knob/lever one side of door only. Plug through edge of door ensures stability.
09	Double Dummy Trim				Rigid knob/lever both sides of door. Plug through edge of door ensures stability.
11	Apartment/Front Door	F12/86F			Latchbolt by knob/lever either side except when outside knob/lever is locked by stopworks in lock front, or when the deadbolt is projected. Deadbolt operates by key outside and turnpiece inside. Turning inside knob/lever will retract latchbolt and deadbolt simultaneously.
12	Storeroom	F07/86EW			Outside knob/lever always rigid. Latchbolt retracted only by key outside or by inside knob/lever. Auxiliary latchbolt deadlocks latchbolt.
13	Apartment/Front Door	F21/86B			Latchbolt operated by knob/lever either side. Deadbolt operated by key outside and turnpiece inside. When deadbolt is projected, key outside will retract deadbolt, then latchbolt.
15	Hotel	F15/86H			Inside knob/lever always free, while outside knob/lever is always rigid. Latchbolt operated by knob/lever inside and by key outside. All keys except emergency keys are shut out when deadbolt is projected by turnpiece inside. Turning inside knob/lever will retract both the deadbolt and the latchbolt simultaneously. Auxiliary latchbolt deadlocks latchbolt. Furnished with visual indicator button.
16	Hotel	F15/86H			Inside knob/lever always free, while outside knob/lever is always rigid. Latchbolt operated by knob/lever inside and by key outside. All keys except emergency keys are shut out when deadbolt is projected by turnpiece inside. Turning inside knob/lever will retract both the deadbolt and the latchbolt simultaneously. Auxiliary latchbolt deadlocks latchbolt.

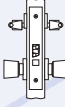
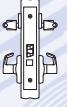
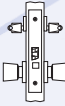
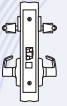
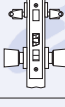
AM/BM Series Mortise Locks

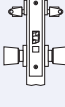
ARROW	Function	ANSI/ Federal #	AM Series	BM Series	Description
17	Classroom	F05/86J			Latchbolt operated by knob/lever either side, except when outside knob/lever is locked by key outside. Key operates latch or unlocks outside knob/lever. Inside knob/lever is always free. Auxiliary latchbolt deadlocks latchbolt.
19	Dormitory/Exit	F13/86FW			Latchbolt operated by knob/lever either side. When outside knob/lever is locked by projected deadbolt, (by inside turnpiece or outside key) key outside will retract deadbolt, then latchbolt. Turning inside knob/lever will retract latchbolt and deadbolt simultaneously, which will unlock outside knob/lever. When deadbolt is projected, the latchbolt is deadlocked.
20	Entrance/ Dormitory	F20			Latchbolt operated by knob/lever either side, except when outside knob/lever is locked by stopworks in lock front, or by projecting deadbolt by turnpiece inside or key outside. Turning inside knob/lever will retract latchbolt and deadbolt simultaneously. Deadbolt operated by turnpiece inside or key outside. When deadbolt is projected the latchbolt is deadlocked. Auxiliary latchbolt deadlocks latchbolt.
21	Front Door	F08,F10/86A			Latchbolt operated by knob/lever either side except when outside knob/lever is locked by stopworks in lock front. Deadbolt is operated by turnpiece inside. Auxiliary latchbolt deadlocks latchbolt. Key outside operates both bolts.
22	Office	F04/86E			Latchbolt operated by knob/lever either side except when outside knob/lever is locked by stopworks in lock front then operated by key outside. Auxiliary latchbolt deadlocks latchbolt.
23	Vestibule				Latchbolt operated by knob/lever either side, except when outside knob/lever is locked by stopworks in lock front, then operated by key outside.
24	Storeroom				Latchbolt operated by knob/lever inside and by key outside. Outside knob/lever always rigid. Inside knob/lever always free.
26	Privacy	F22/86L			Latchbolt by knob/lever either side, except when outside is locked by turnpiece inside. Operating inside knob/lever, closing door, or with outside emergency release unlocks outside.
27	Institutional				Latchbolt by knob/lever either side, except when Privacy outside is locked by turnpiece inside. Operating inside knob/lever or closing door unlocks outside. Key outside retracts latch at all times, even if thumbturn is held in locked position. Auxiliary latch deadlocks latchbolt.
31	Storeroom	F14/86C			Latchbolt operated by knob/lever either side. Deadbolt is operated by key from either side. When deadbolt is projected, key either side will retract deadbolt, then latchbolt.

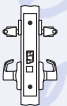
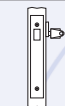
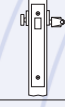
AM/BM Series Mortise Locks

ARROW	Function	ANSI/ Federal #	AM Series	BM Series	Description
32	Vestibule	F09/86G			Latchbolt operated by knob/lever either side, except when outside knob/lever is locked by key from the inside cylinder. When outside knob/lever is locked, latchbolt is retracted by key outside or by knob/lever inside. Auxiliary latchbolt deadlocks latchbolt.
33	Storeroom	F30			Both knobs/levers rigid at all times. Auxiliary latchbolt deadlocks latchbolt. Latchbolt operated only by key from either side.
34	Storeroom	F35			Latchbolt operated by knob/lever either side except when the outside knob/lever is locked by stop works in lock front then operated by key outside or by knob/lever inside. Deadbolt operated by key from either side.
37	Classroom	F32			Latchbolt by knob/lever either side. Except when outside is locked from inside or outside by key. When outside is locked, latchbolt is retracted by key from inside or outside or by operating inside knob/lever. Auxiliary latch deadlocks latchbolt.
38	Classroom				Latchbolt by lever from either side unless outside lever is locked by projection of deadbolt. Deadbolt thrown by key from either side. Inside lever simultaneously retracts latchbolt and deadbolt, outside lever remains locked. Retracting latchbolt by key unlocks outside lever. Auxiliary latch deadlocks latchbolt.
40	Deadlock	F18/86S			Deadbolt operated only by key outside. (No trim)
41	Deadlock	F17/86P			Deadbolt operated by key outside and turnpiece inside. (No trim)
42	Deadlock	F16/86T			Deadbolt operated by key from either side. (No trim)
44	Classroom Deadlock				Deadbolt by key outside. Turnpiece will retract but will not project bolt.

Electrical Lock Functions:

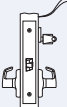
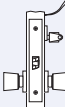
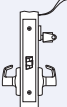
AM17/BM17 SUFFIX	VOLTAGE *	CURRENT			DESCRIPTION
177	12VAC	612mA			FAIL SAFE: Power on locks outside lever. Inside lever always free. Latch retracted by key when locked electrically.
178	12VDC	612mA			
179	24VAC	330mA			
180	24VDC	330mA			
181	12VAC	612mA			FAIL SECURE: Power off locks outside lever. Inside lever always free. Latch retracted by key when locked electrically.
182	12VDC	612mA			
183	24VAC	330mA			
184	24VDC	330mA			

* Specify AC or DC

AM/BM Series Mortise Locks

Reversing Hand

Mortise Locksets AM/BM Series

Please read completely before proceeding and review the drawing below.

Minimal force is required to reverse handing.

1. Remove the armored front.
2. Remove the lockset from the door.
3. Fully depress the latchbolt and hold in the depressed position.
4. With minimal force, depress the catch plate, located at the end of the latchtail, through the oblong cutout in the lockcase cap. While depressing the catch plate, release the latchbolt and remove latch from the lock.
5. Turn the latchbolt over and reinstall into the lock.
6. Depress the latchbolt until it re-engages the tail socket.
7. Remove the red headed screw from the stopworks and place it in the stopworks on the opposite side of the case.
8. Loosen the front screw to change the bevel. Tighten the front screws.
9. Reinstall the lock and armored front into the door.
10. If changing bevel only, i.e. RH to RHR. Omit step 7.

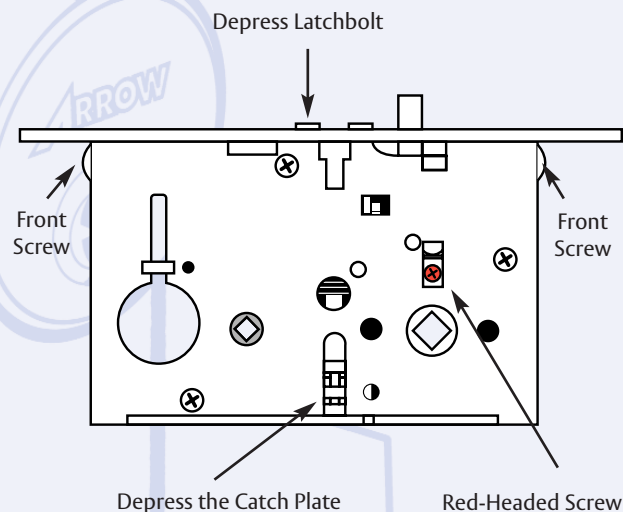

AM/BM Series Mortise Locks

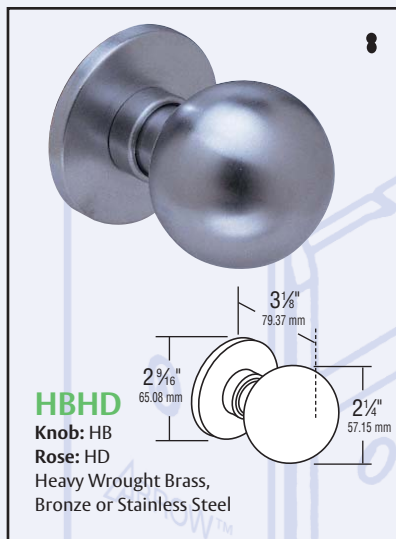

HBHD
Knob: HB
Rose: HD
 Heavy Wrought Brass,
 Bronze or Stainless Steel

Dimensions: 2 9/16" (65.08 mm), 3 1/8" (79.37 mm), 2 1/4" (57.15 mm)

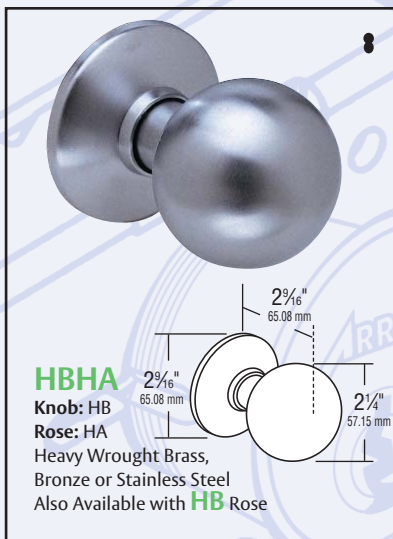

HBHA
Knob: HB
Rose: HA
 Heavy Wrought Brass,
 Bronze or Stainless Steel
 Also Available with **HB** Rose

Dimensions: 2 9/16" (65.08 mm), 2 9/16" (65.08 mm), 2 1/4" (57.15 mm)

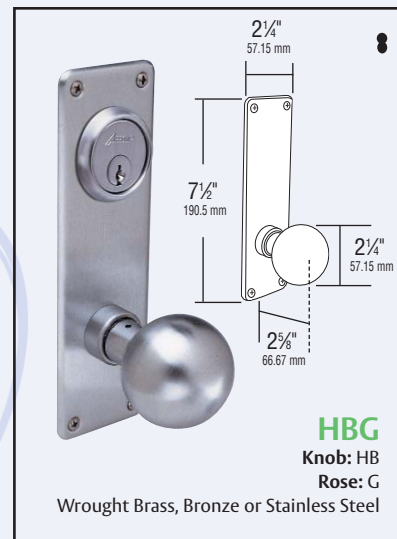

HBG
Knob: HB
Rose: G
 Wrought Brass, Bronze or Stainless Steel

Dimensions: 2 1/4" (57.15 mm), 7 1/2" (190.5 mm), 2 1/4" (57.15 mm), 2 5/8" (66.67 mm)

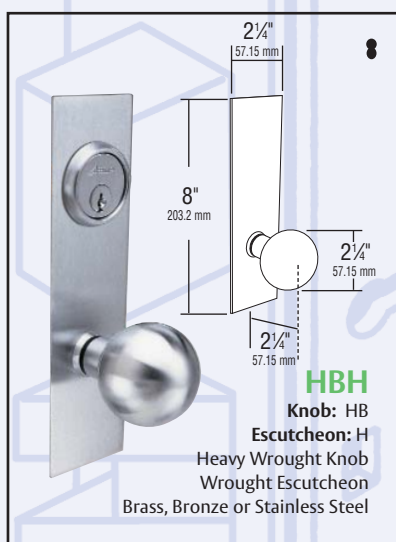

HBH
Knob: HB
Escutcheon: H
 Heavy Wrought Knob
 Wrought Escutcheon
 Brass, Bronze or Stainless Steel

Dimensions: 2 1/4" (57.15 mm), 8" (203.2 mm), 2 1/4" (57.15 mm), 2 1/4" (57.15 mm)

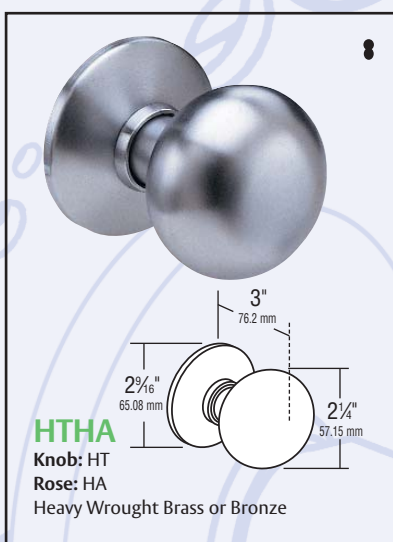

HTHA
Knob: HT
Rose: HA
 Heavy Wrought Brass or Bronze

Dimensions: 3" (76.2 mm), 2 9/16" (65.08 mm), 2 1/4" (57.15 mm)

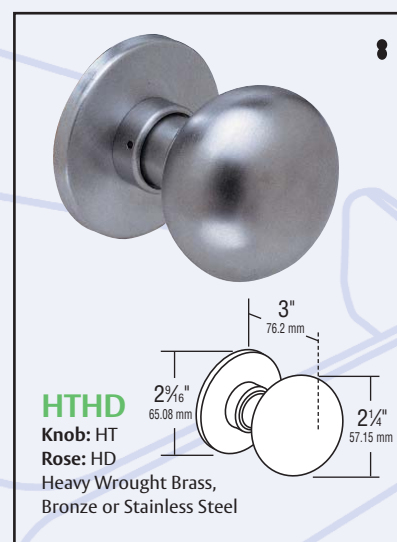

HTHD
Knob: HT
Rose: HD
 Heavy Wrought Brass,
 Bronze or Stainless Steel

Dimensions: 3" (76.2 mm), 2 9/16" (65.08 mm), 2 1/4" (57.15 mm)



HTHB
Knob: HT
Rose: HB
 Heavy Wrought Brass,
 Bronze or Stainless Steel

Dimensions: 3 1/4" (82.55 mm), 3" (76.2 mm), 2 1/4" (57.15 mm)

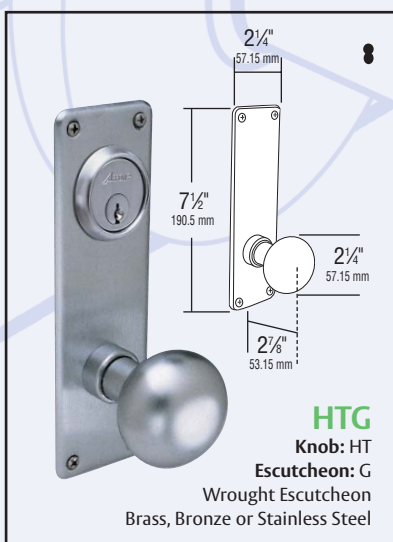

HTG
Knob: HT
Escutcheon: G
 Wrought Escutcheon
 Brass, Bronze or Stainless Steel

Dimensions: 2 1/4" (57.15 mm), 7 1/2" (190.5 mm), 2 1/4" (57.15 mm), 2 7/8" (73.02 mm)



HTH
Knob: HT
Escutcheon: H
 Heavy Wrought Knob
 Wrought Escutcheon
 Brass, Bronze or Stainless Steel

Dimensions: 2 1/4" (57.15 mm), 8" (203.2 mm), 2 1/4" (57.15 mm), 2 7/8" (73.02 mm)

AM/BM Series Mortise Locks

ASSA ABLOY, the global leader
 in door opening solutions



AM/BM Series mortise locks / AM Series Knob Designs

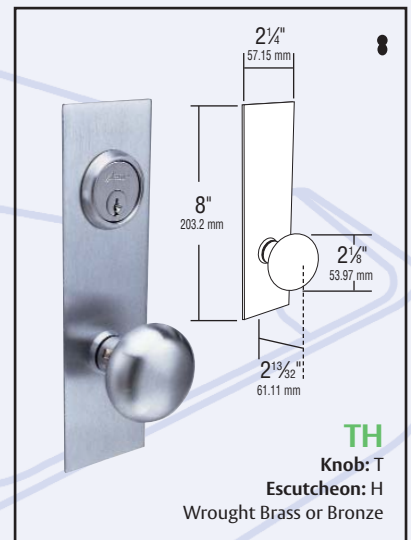
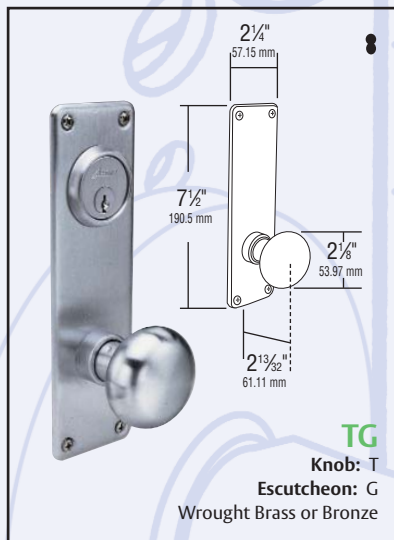
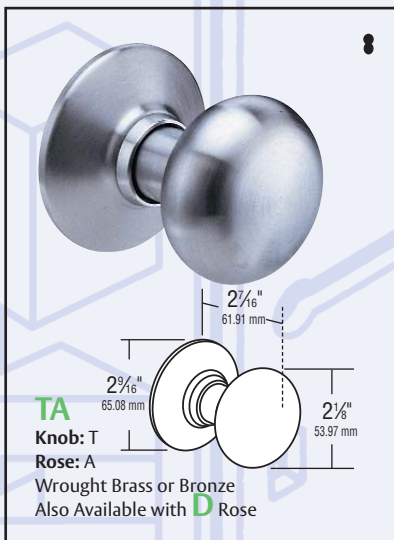
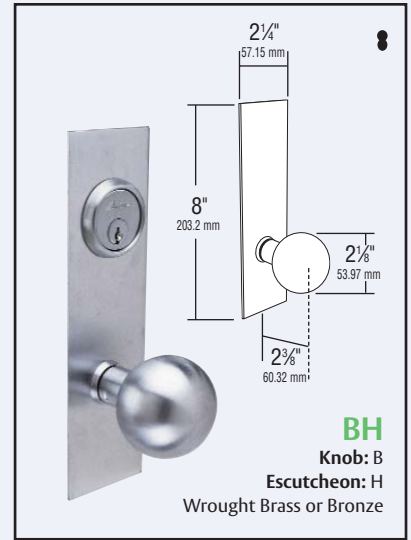
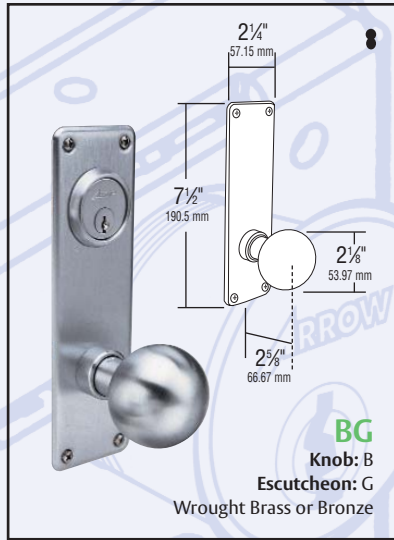
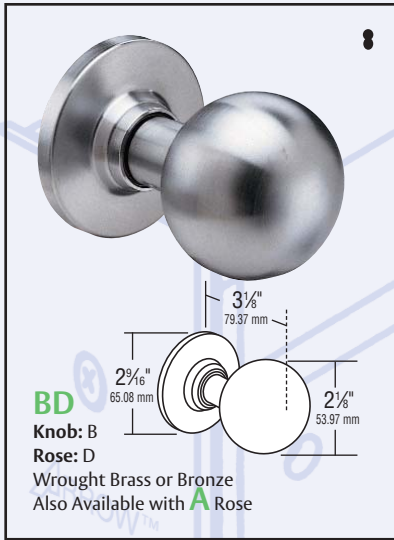

AM/BM Series Mortise Locks

ASSA ABLOY, the global leader in door opening solutions



ASSA ABLOY

Broadway

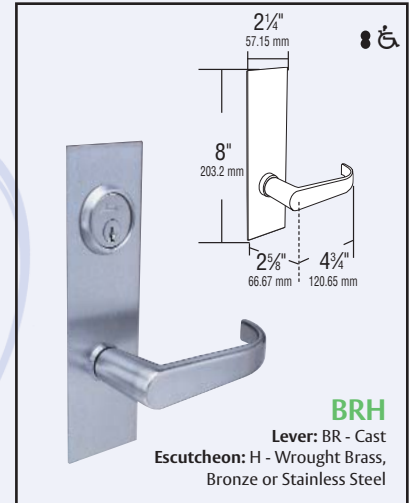
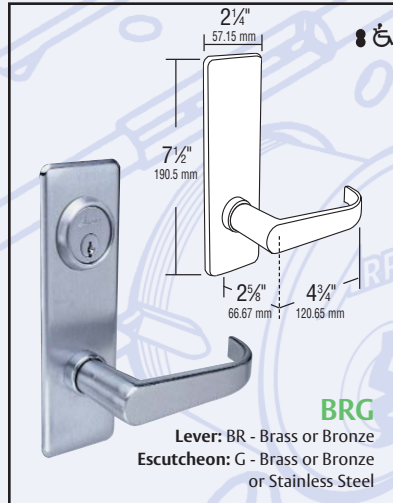
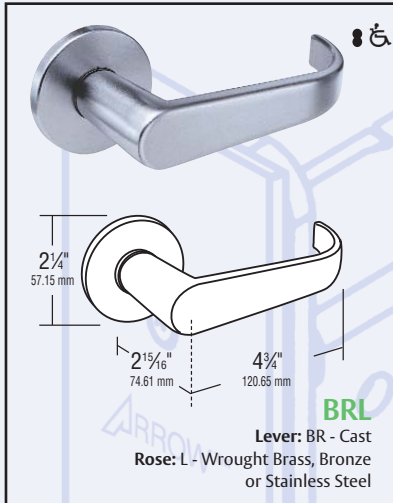

Hastings

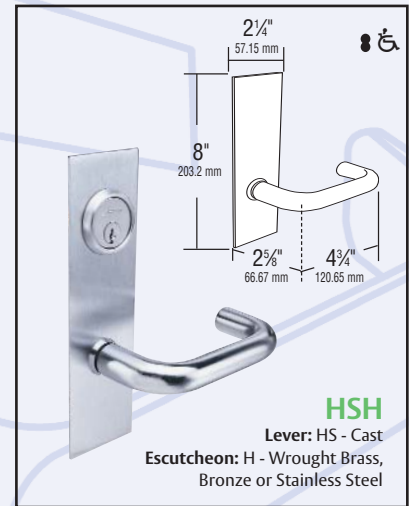
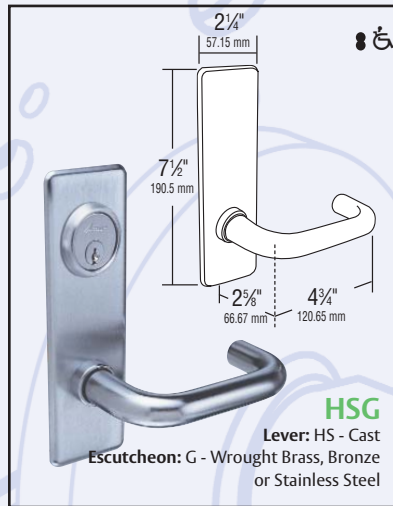
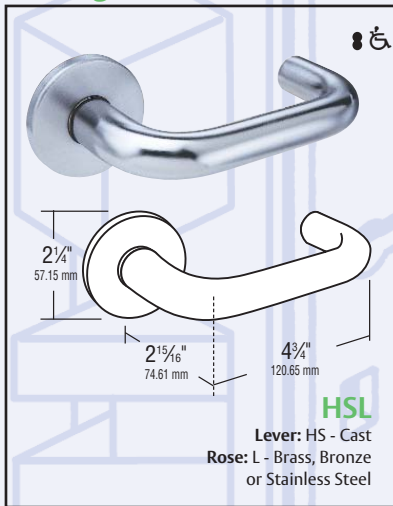

Javelin

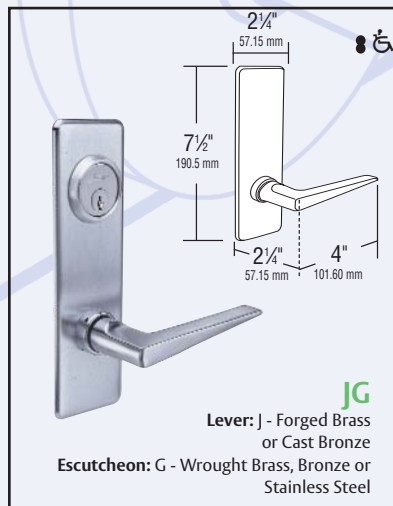
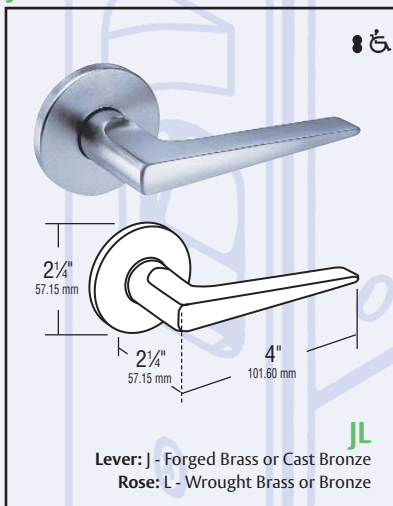

AM/BM Series Mortise Locks

Neo

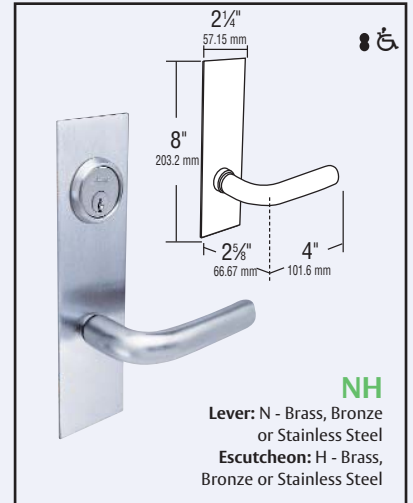
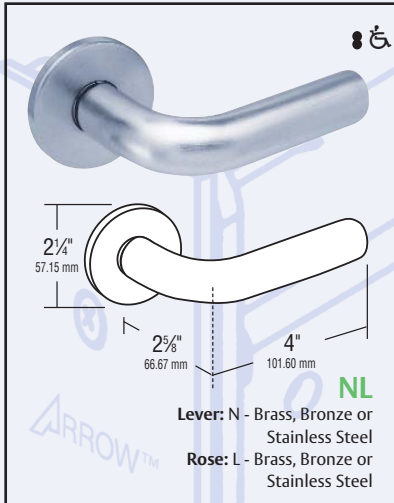

Ventura

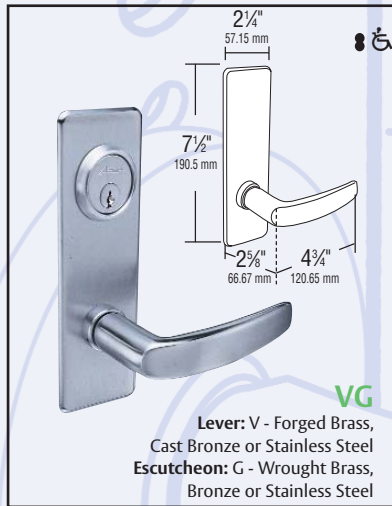
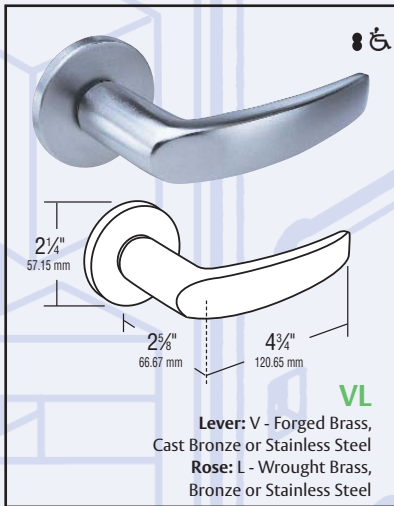

Wave

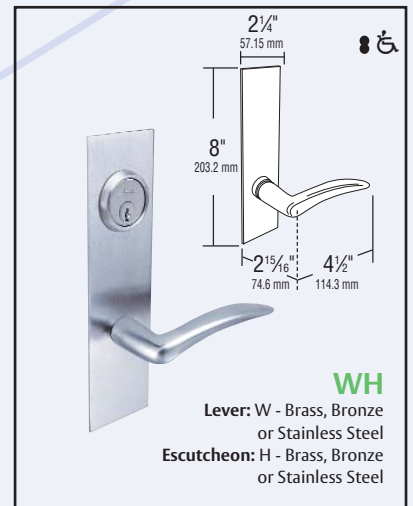
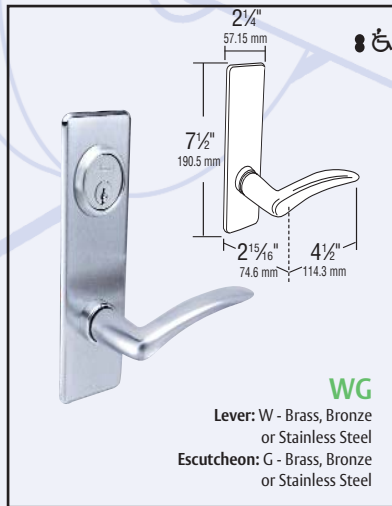

AM/BM Series Mortise Locks

Xavier

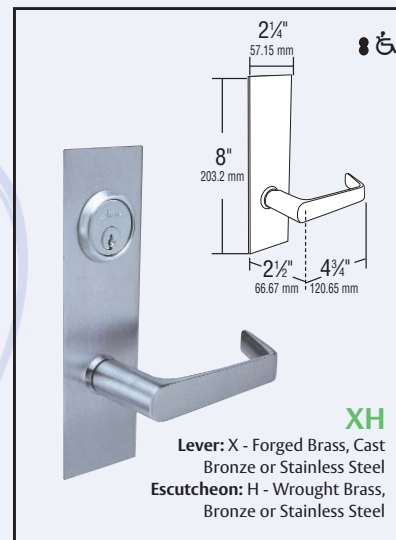
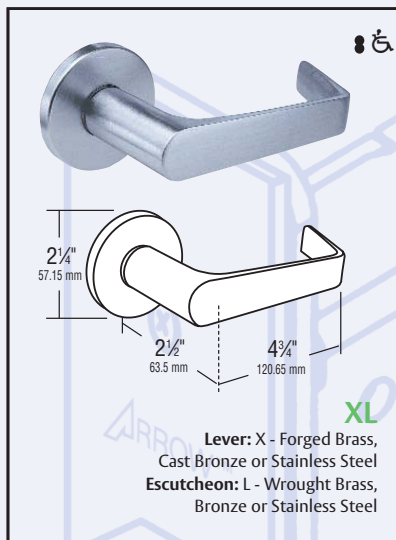

Strikes

ANSI Straight Lip (standard)

- Brass or bronze
- Non-handed
- 4-7/8" (124mm) x 1-1/4" (32mm) x 1-1/8" (29mm) lip to center
- Optional lip lengths: 7/8" (22mm), 1-1/4" (32mm), 1-3/8" (35mm), 1-1/2" (38mm), 1-3/4" (44mm), 2" (51mm), 2-1/4" (57mm), 2-1/2" (64mm), 2-3/4" (70mm), 3" (76mm)

ANSI Curved Lip

- Brass or bronze
- Handed
- 4-7/8" (124mm) x 1-1/4" (32mm) x 1-1/4" (32mm) lip to center
- Optional lip lengths: 1-3/8" (35mm), 1-1/2" (38mm), 1-3/4" (44mm), 2" (51mm), 2-1/4" (57mm), 2-1/2" (64mm), 2-3/4" (70mm), 3" (76mm)

		PART NO.	DESCRIPTION
Latchbolt x Deadbolt Functions: 02,11,13,15,16, 19,20,21,31,34		460	Straight Lip
		468	Curved Lip for RH
		466	Curved Lip for LH
Latchbolt Only Functions: 01,07,12,17,22,23, 24,26,27,32,33,37		463	Straight Lip
		464	Curved Lip for RH
		462	Curved Lip for LH
Deadbolt Only Functions: 40,41,42,44		456	Straight Lip

Note: Straight lip strikes are standard.
Specify if curved lip strike is required.

Cylinder

Cylinder

- MC61 - 1-1/8" for 1-3/4" door. Collar-16-113A
- Hotel Cylinder
For function 15 and 16.
MCH61 - 1-18" for 1-3/4" door. Collar-16-113A
- Finishes - 3, 4, 10, 10B, 26, 26D.

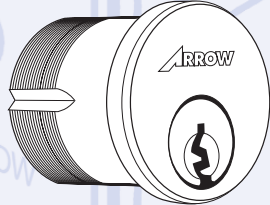

Cylinder for Interchangeable Core

- C16-CR-16 - 6pin-1-1/8"
- C16-CR-27 - 6 or 7 pin 1-1/4"
- C16-CRH-26 - 6 pin, hotel
- Collar - 16-113A
- Finishes - 3, 4, 10, 10B, 26, 26D

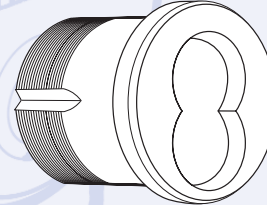

Cylinder Collars

I.C. Mortise Cylinder Collar 16-113A
(Standard for 16CR-14, 16CR-26, 16CRH-26)



I.C. Rim Cylinder Collar 16RC-113
(Standard for 16RCR-16, 16RCR-27)



Spacer Rings

16CR-123-1
1/8" Thick



16CR-123-2
1/4" Thick

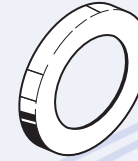

16CR-123-3
(Standard for 16RCH-26)
3/8" Thick



Thumb Turn 16-17A

- Furnished with rose trim. For escutcheon trim, thumb turn is mounted on escutcheon.
- Finishes - 3, 4, 10, 10B, 26, 26D

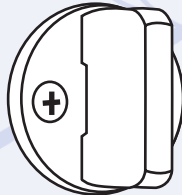

Cams

001



Used with functions 12, 17, 22, 23, 24, 27, 32 (I/S), 33, 37

AM2



Used with deadbolt functions 11, 13, 15, 16, 19, 20, 21, 31, 32 (O/S), 34, 40, 41, 42, 44

AM/BM Series Mortise Locks

Face Plates (Scalps)

Part No.
AM-15-305

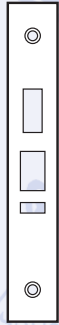

Function
15, 16

Part No.
AM11-305



Function
11, 21, 34

Part No.
AM12-305



Function
07, 12, 17
27, 32, 33, 37

Part No.
AM02-305



Function
02, 13, 19, 31

Part No.
AM22-305



Function
22

Part No.
AM23-305



Function
23

Part No.
AM41-305



Function
40, 41, 42, 44

Part No.
AM01-305

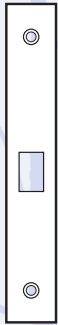

Function
01, 24, 26

Part No.
AM20-305



Function
20

Spindles



Knob Spindle

AM 385A–For trim with “H” escutcheon
AM 386A–For trim with “G” escutcheon and all rose trim

NOTE: AM 385A–Inside half-P/N-16-385
Outside half-P/N-BM-383
AM 386A–Inside half-P/N-16-385
Outside half-P/N-BM-383-2



Lever Spindle

BM 385A–For trim with “H” escutcheon and rose trim
BM 386A–For trim with “G” escutcheon

NOTE: BM 385A–Inside half (assembly with screw) 17S-384A
Outside half-BM-383
BM 386A–Inside half (assembly with screw) 17S-385A
Outside half-BM-383-2

Suggested Specification AM/BM

All locksets shall be Mortise Locksets as supplied by Arrow Lock company.

Locks shall have all functions available in one size case, manufactured from heavy gauge steel, minimum thickness 3/32", chrome plated for corrosion resistance and lubricity of parts. The handing of all locks shall be reversible without the disassembly of the lockcase. Cases are to be closed on all sides to protect internal parts. Locks are to have adjustable, beveled and armored fronts, standard 2-3/4" backset, a full 3/4" throw two-piece mechanical anti-friction latchbolt, and a one-piece stainless steel 1" throw deadbolt, and shall be available for a minimum door thickness of 1-3/8". Internal parts shall be heavy gauge steel, zinc dichromate plated for corrosion resistance.

All locksets with latchbolts, regardless of trim, shall be listed by Underwriters Laboratories for A label and lesser class doors, 4' x 10' single or 8' x 10' pair. Cylinder options shall include interchangeable core.

Lock trim (knob, lever, sectional or escutcheon) shall be throughbolted through the lockcase to assure correct alignment and proper operation.

Certification

UBC-7(1997) and UL10C-Positive Pressure
 Federal Specification FF0H-106G
 ANSI A156.13 Series 1000, Operational Grade 1
 ANSI A117.1, Accessibility Code, 1989 (Formerly Title 19, California State Fire Marshal Standard) (lever handle trim).

All locks, trim, and cylinders shall be from one manufacturer.

All locksets shall carry a five-year limited warranty.

How To Specify

Example: To order a AM Series Apartment function Mortise lock with HTHA design, satin chrome finish, with a straight lip strike, right handed, keyed different.

Specify:

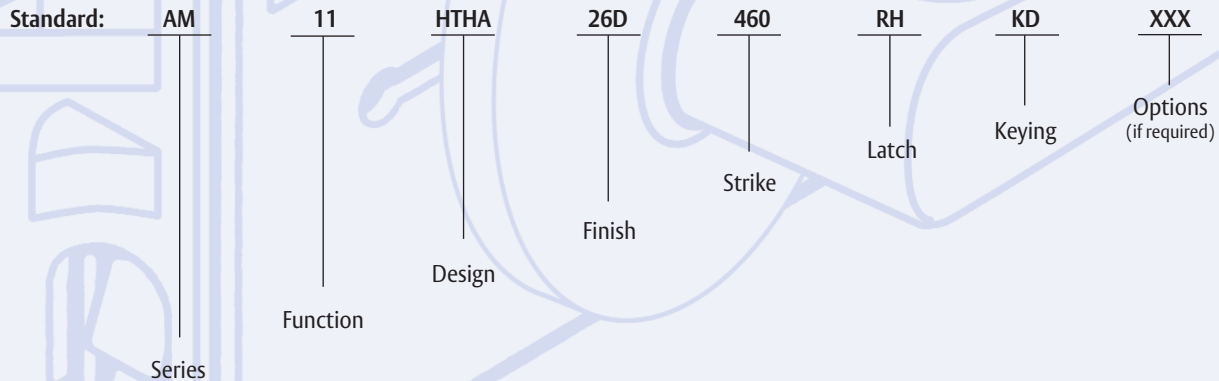

AM/BM Series Mortise Locks

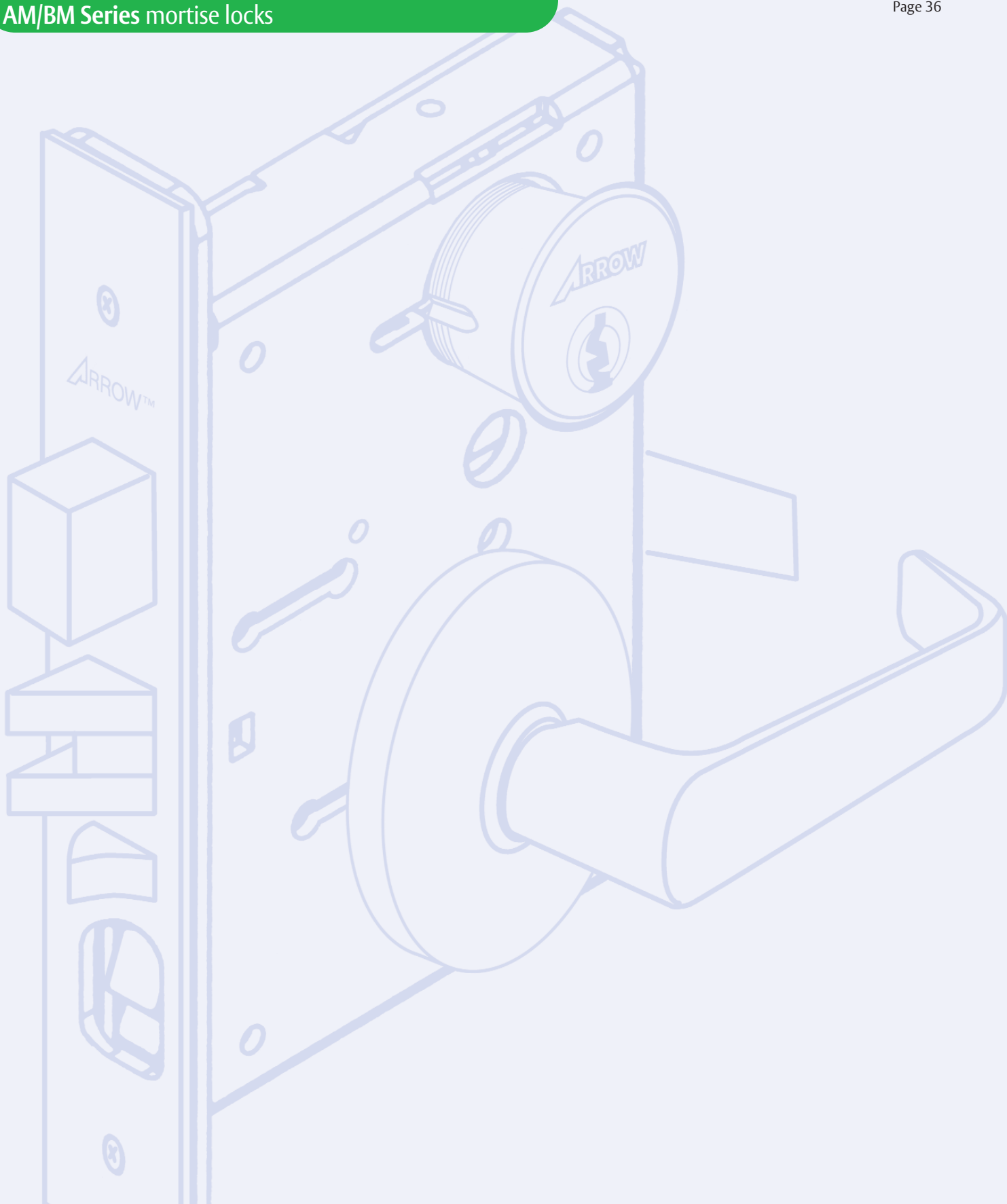

AM/BM Series Mortise Locks

ASSA ABLOY, the global leader
in door opening solutions



ASSA ABLOY



LIGHT PRODUCTS												
SPIC	MORTISE LOCKS	CYLINDRICAL LEVERS	TUBULAR LOCKS	CYLINDRICAL KNOBS	DEADBOLTS	DOOR CLOSERS	INTER-CONNECTED LOCKS	ALARMED HARDWARE	ELECTRONIC DEVICES			
9000	3000	4000	5000	1000	3000	4000	5000	1000	3000	4000	5000	1000
Grade 1 2 finishes	Grade 1 4 finishes: mortise, rim & SVR 3 styles: mortise, rim & SVR	Grade 1 4 finishes: mortise, rim & SVR, CVR 3 styles: mortise, rim & SVR	Grade 1 4 finishes: mortise, rim & SVR, CVR 3 styles: mortise, rim & SVR	Grade 1 4 finishes: mortise, rim & SVR, CVR 3 styles: mortise, rim & SVR	Grade 1 4 finishes: mortise, rim & SVR, CVR 3 styles: mortise, rim & SVR	Grade 1 4 finishes: mortise, rim & SVR, CVR 3 styles: mortise, rim & SVR	Grade 1 4 finishes: mortise, rim & SVR, CVR 3 styles: mortise, rim & SVR	Grade 1 4 finishes: mortise, rim & SVR, CVR 3 styles: mortise, rim & SVR	Grade 1 4 finishes: mortise, rim & SVR, CVR 3 styles: mortise, rim & SVR	Grade 1 4 finishes: mortise, rim & SVR, CVR 3 styles: mortise, rim & SVR	Grade 1 4 finishes: mortise, rim & SVR, CVR 3 styles: mortise, rim & SVR	Grade 1 4 finishes: mortise, rim & SVR, CVR 3 styles: mortise, rim & SVR
9000	3000	4000	5000	1000	3000	4000	5000	1000	3000	4000	5000	1000
Grade 2 7 functions 2 lever designs 6 finishes IC core option	Grade 2 7 functions (ML) 3 lever designs (ML) 2 lever designs (L) 6 finishes Overdrive Cylinder (ML) IC core option (ML)	Grade 2 7 functions (ML) 3 lever designs (ML) 2 lever designs (L) 6 finishes Overdrive Cylinder (ML) IC core option (ML)	Grade 2 7 functions (ML) 3 lever designs (ML) 2 lever designs (L) 6 finishes Overdrive Cylinder (ML) IC core option (ML)	Grade 2 7 functions (ML) 3 lever designs (ML) 2 lever designs (L) 6 finishes Overdrive Cylinder (ML) IC core option (ML)	Grade 2 7 functions (ML) 3 lever designs (ML) 2 lever designs (L) 6 finishes Overdrive Cylinder (ML) IC core option (ML)	Grade 2 7 functions (ML) 3 lever designs (ML) 2 lever designs (L) 6 finishes Overdrive Cylinder (ML) IC core option (ML)	Grade 2 7 functions (ML) 3 lever designs (ML) 2 lever designs (L) 6 finishes Overdrive Cylinder (ML) IC core option (ML)	Grade 2 7 functions (ML) 3 lever designs (ML) 2 lever designs (L) 6 finishes Overdrive Cylinder (ML) IC core option (ML)	Grade 2 7 functions (ML) 3 lever designs (ML) 2 lever designs (L) 6 finishes Overdrive Cylinder (ML) IC core option (ML)	Grade 2 7 functions (ML) 3 lever designs (ML) 2 lever designs (L) 6 finishes Overdrive Cylinder (ML) IC core option (ML)	Grade 2 7 functions (ML) 3 lever designs (ML) 2 lever designs (L) 6 finishes Overdrive Cylinder (ML) IC core option (ML)	Grade 2 7 functions (ML) 3 lever designs (ML) 2 lever designs (L) 6 finishes Overdrive Cylinder (ML) IC core option (ML)
9000	3000	4000	5000	1000	3000	4000	5000	1000	3000	4000	5000	1000
Grade 1 2 styles: rim & SVR (1200) 3 styles: mortise, rim & SVR (1700) 4 finishes (1250) 6 finishes (1700)	Grade 1 2 styles: rim & SVR (1200) 3 styles: mortise, rim & SVR (1700) 4 finishes (1250) 6 finishes (1700)	Grade 1 2 styles: rim & SVR (1200) 3 styles: mortise, rim & SVR (1700) 4 finishes (1250) 6 finishes (1700)	Grade 1 2 styles: rim & SVR (1200) 3 styles: mortise, rim & SVR (1700) 4 finishes (1250) 6 finishes (1700)	Grade 1 2 styles: rim & SVR (1200) 3 styles: mortise, rim & SVR (1700) 4 finishes (1250) 6 finishes (1700)	Grade 1 2 styles: rim & SVR (1200) 3 styles: mortise, rim & SVR (1700) 4 finishes (1250) 6 finishes (1700)	Grade 1 2 styles: rim & SVR (1200) 3 styles: mortise, rim & SVR (1700) 4 finishes (1250) 6 finishes (1700)	Grade 1 2 styles: rim & SVR (1200) 3 styles: mortise, rim & SVR (1700) 4 finishes (1250) 6 finishes (1700)	Grade 1 2 styles: rim & SVR (1200) 3 styles: mortise, rim & SVR (1700) 4 finishes (1250) 6 finishes (1700)	Grade 1 2 styles: rim & SVR (1200) 3 styles: mortise, rim & SVR (1700) 4 finishes (1250) 6 finishes (1700)	Grade 1 2 styles: rim & SVR (1200) 3 styles: mortise, rim & SVR (1700) 4 finishes (1250) 6 finishes (1700)	Grade 1 2 styles: rim & SVR (1200) 3 styles: mortise, rim & SVR (1700) 4 finishes (1250) 6 finishes (1700)	Grade 1 2 styles: rim & SVR (1200) 3 styles: mortise, rim & SVR (1700) 4 finishes (1250) 6 finishes (1700)

Cylindrical Lever Locks

Q, W, ML, L, RL Series

ASSA ABLOY, the global leader in door opening solutions



Arrow's Q Series Grade 1 cylindrical lever locks have been engineered for years of dependable operation. The Q combines flexible installation with the optional OverDrive™ freewheeling feature for use in the widest possible range of applications.

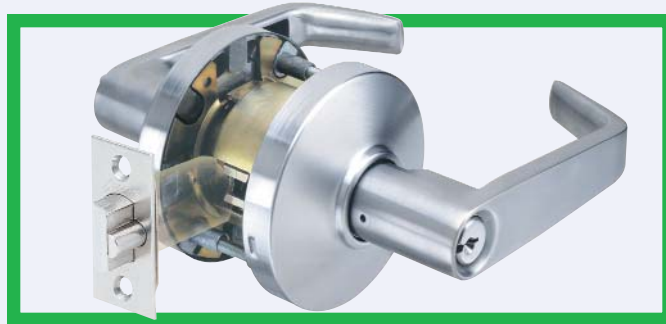

Certification:



All Arrow Q Series locks are U.L. and c.U.L. listed for use on 3 hour, A label or lesser doors and are certified to conform to and exceed the requirements of ANSI/BHMA A156.2, Series 4000, Grade 1.

- Federal Specification FF-H-106C
- ANSI A117.1 Accessibility Code
- California State Reference Code for levers returning to within 1/2" (12.7mm) of door surface

Features:

Housing—Cold rolled steel, with zinc dichromated finish for rust resistance. Latch retractor is precision cast steel. Extra long bearing sleeve offers added support for interlocking tubes and provides for extra lever rigidity.

Requires standard 2-1/8" (53.97mm) bore through door.

Thru-Bolts—Patented flexible adaptor, an eight sided nickel steel alloy mechanism allows for universal thru-bolt location according to door preparation. The flexible mounting is accomplished without manually removing screw posts from rose insert. The flexible adaptor also engages directly with springs, which will virtually eliminate lever sag.



OverDrive™ will allow a locked lever to rotate freely without retracting the latch, improving the life and performance of Arrow locksets.

OverDrive™—Freewheeling lever action occurs when latch retraction mechanism disengages from lever handle when handle is locked. Built-in stops in the rose insert prevent lever from traveling beyond approximately 57 degrees. Additional 40% spring power in rose insert on OverDrive™ side of door ensures that lever handle returns to horizontal position.

Backset—2-3/4" (69.85mm) standard. 3-3/4" (95.25mm) and 5" (127mm) available.

Latch—Brass with 1/2" (12.7mm) throw standard. 3/4" (19.05mm) throw deadlocking firelatch is available for pairs of doors. Latch housing is steel, zinc dichromate finish for corrosion resistance. 1" (25.4mm) bore in edge of door is required.

ADA/Americans with Disabilities Act:

Acceptable Door Hardware: Section 4.13.9

Handles, pulls, latches and other operating devices on accessible doors shall have a shape that is easy to grasp with one hand and does not require grasping, tight pinching or twisting of the wrist to operate. Lever operated mechanisms, push-type mechanisms and "U" shaped handles are acceptable designs.

 Look for the universal symbol next to Arrow products that comply with ADA accessibility requirements.

Latch Front—Brass, bronze or stainless steel. 2-1/4" (57.15mm) x 1-1/8" (28.57mm) beveled, 1/8" (3.175mm) in 2" (50.8mm).

Exposed Trim—Levers are pressure cast zinc. Streamline rose scalp of brass or bronze complements other series of lever locks.

Rose Inserts—Contain coil spring which is a permanent assembly within rose insert. The inside insert has graduating steps in two locations to prevent rose scalp from loosening. A "catch" on the outside insert prevents rose scalp from working itself loose during installation.

Strikes—Brass, bronze or stainless steel. ANSI A115.2, 4-7/8" (123.82mm) x 1-1/4" (31.75mm) curved lip strike standard. Optional 2-3/4" (69.85mm) x 1-1/8" (28.57mm) strike available. All strikes have 1-1/4" (31.75mm) lip to center dimension.

Door Thickness—1-3/4" (44.45mm).

Handing—Non-handed. Levers operate bi-directionally.

Finishes—US3,US4,US10,US10B,US26,US26D. Consult factory for the availability of other non-listed finishes.

Packaging—1 per box, 10 per case.

Warranty—Limited three year warranty.

Q Series Cylindrical Lever

Designs

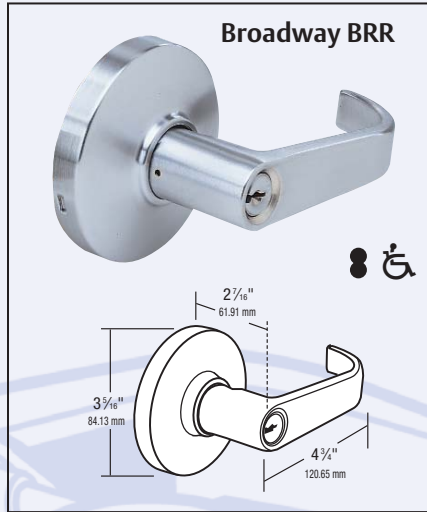
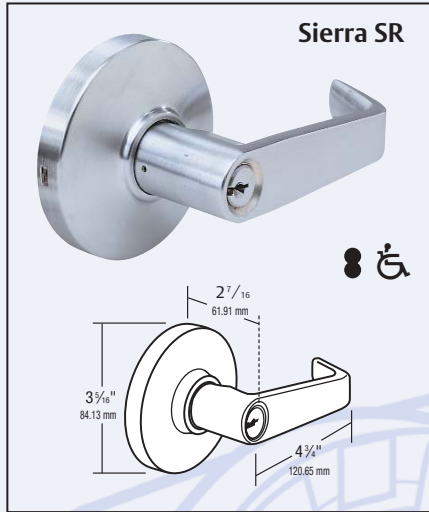

Finishes



BHMA	U.S. Equivalent	Arrow Equivalent	Finish
1	605 US3	03	Bright Brass
2	606 US4	04	Satin Brass
3	612 US10	10	Satin Bronze
4	613 US10B	10B	Dark Oxide Bronze, Oil Rubbed
5	625 US26	26	Bright Chromium Plated
6	626 US26D	26D	Satin Chromium Plated

Cylinder Options

Conventional—Q Series locksets are supplied standard with Arrow “A” keyway, 6 pin cylinder. As with all other lock series, various levels of masterkeying are available. Conventional cylinders are available in a variety of competitive manufacturers keyways. Supplied with two nickel silver keys.

Interchangeable Core—Lockset prepared to use with 6 or 7 pin interchangeable core. Supplied less core, but packed with tailpiece. Will also accept cores manufactured by Best™, Falcon™, Medeco Keymark™, ASSA™, and others. Suffix “IC” to indicate small format interchangeable core, or “LIC” (SR design only) to indicate Medeco or ASSA High Security large format interchangeable core. Temporary Arrow small format construction cores are also available.

Interchangeable Core

Look for this symbol to indicate availability of product with interchangeable core design.





Q Series Cylindrical Lever

ASSA ABLOY, the global leader in door opening solutions



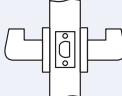
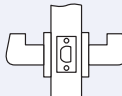

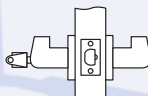
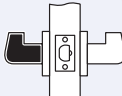
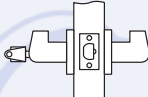
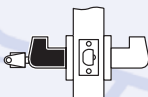
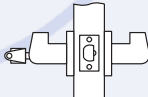
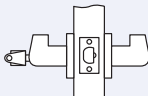
ASSA ABLOY

Functions:

ARROW STANDARD	ARROW OVERDRIVE™	ANSI	FUNCTION	DESCRIPTION
Q01		F75/161N	Passage (No OverDrive™)	 Latchbolt operated by lever either side.
Q02	Q72	F76/161L	Privacy	 Latchbolt operated by lever either side except when inside pushbutton locks outside lever. Unlocked by turning inside lever, using emergency key outside or closing door.
Q03			Communicating (No OverDrive™)	 Latchbolt by inside lever only. Blank rose only outside.
Q06	Q76		Hospital Privacy	 Latchbolt operated by lever either side except when inside pushbutton locks outside lever. Unlocked from outside by key "trapped" in outside lever. Turning inside lever or closing door will also unlock outside lever.
Q07	Q77	F89/161NX	Exit	 Latchbolt operated by inside lever only. Outside lever always rigid.
Q11	Q81	F109 (F81 & F82)	Entrance/Office	 Dead locking latch bolt operated by lever from either side except when outside lever is locked by pushing turn button inside. Key outside or operating inside lever releases turn button unlocking outside lever except when turn button had been rotated to keep outside lever locked. Inside turn button must be manually operated to unlock outside lever. Inside lever always operates latch bolt.
Q12	Q82	F86	Storeroom	 Dead locking latch bolt operated by key in outside lever, or by operating inside lever. Outside lever is always inoperable.
Q13	Q83	F82	Exterior	 Dead locking latch bolt operated by lever from either side except when outside lever is locked by push button inside. When outside lever is locked, operating key in outside lever or operating inside lever unlocks push button and retracts latchbolt. Closing door does not release push button.
Q14	Q84	F92	Service Station	 Dead locking latch bolt operated by lever from either side except when outside lever is locked by push button inside. Key outside, operating inside lever or closing door releases push button unlocking outside lever except when slotted push button is in a locked position. Inside lever always operates latch bolt.
				 Indicates lever rigid at all times.

Q Series Cylindrical Lever

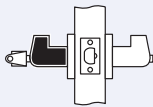
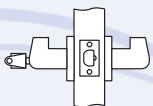
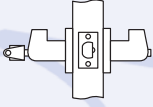
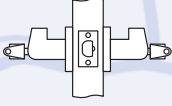
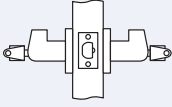
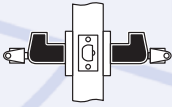
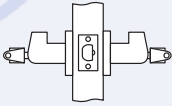
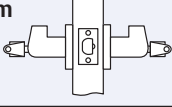
Functions:

ARROW STANDARD	ARROW OVERDRIVE™	ANSI	FUNCTION		DESCRIPTION
Q15	Q85	F93/161H	Hotel		Latchbolt operated by inside lever at all times. Outside lever rigid at all times. Key outside will retract latch except when pushing inside button shuts out all keys except emergency key and activates visual occupancy indicator on face of cylinder. Turning inside lever or closing door releases button and retracts visual indicator. Turning inside button with spanner key will lock button in fixed position. Button then released with spanner or emergency key.
Q17	Q87	F84/161R	Classroom		Latchbolt operated by lever either side except when key outside locks outside lever. Inside lever always free. Key outside locks/unlocks outside lever only.
Q19	Q89	F90	Dormitory		Deadlocking latch bolt operated by lever from either side except when outside lever is locked by key in outside lever or by push button inside. Key in outside lever locks or unlocks outside lever. Operating inside lever releases push button placed in a locked position. Closing door releases push button. Inside lever always operates latch bolt.
Q31	Q91	F80	Communicating		Dead locking latch bolt operated by lever from either side. Turning key in either lever locks or unlocks its own lever independently. Do not use on doors in rooms that have no other entrance.
Q32	Q92	F88	Public Entrance		Dead locking latch bolt operated by lever from either side except when outside lever is locked by key from inside. When outside lever is locked, latch bolt is retracted by key in outside lever or by operating inside lever.
Q33	Q93	F87	Asylum		Dead locking latch bolt operated by key in lever, from either side. Both levers always inoperable.
Q35	Q95	F91	Exterior		Dead locking latch bolt operated by lever from either side except when both levers are locked by key from either side.
Q37		F110	Intruder Classroom		Deadlocking latch bolt operated by lever from either side. Key either inside or outside locks or unlocks outside lever. Inside lever always operates latchbolt.
					Indicates lever rigid at all times.

Q Series Cylindrical Lever

Installation:

Q Series levers employ the unique flex-adapter which allows thru-bolting installation with pre-existing holes or new installation where conditions allow thru-bolting at any location.

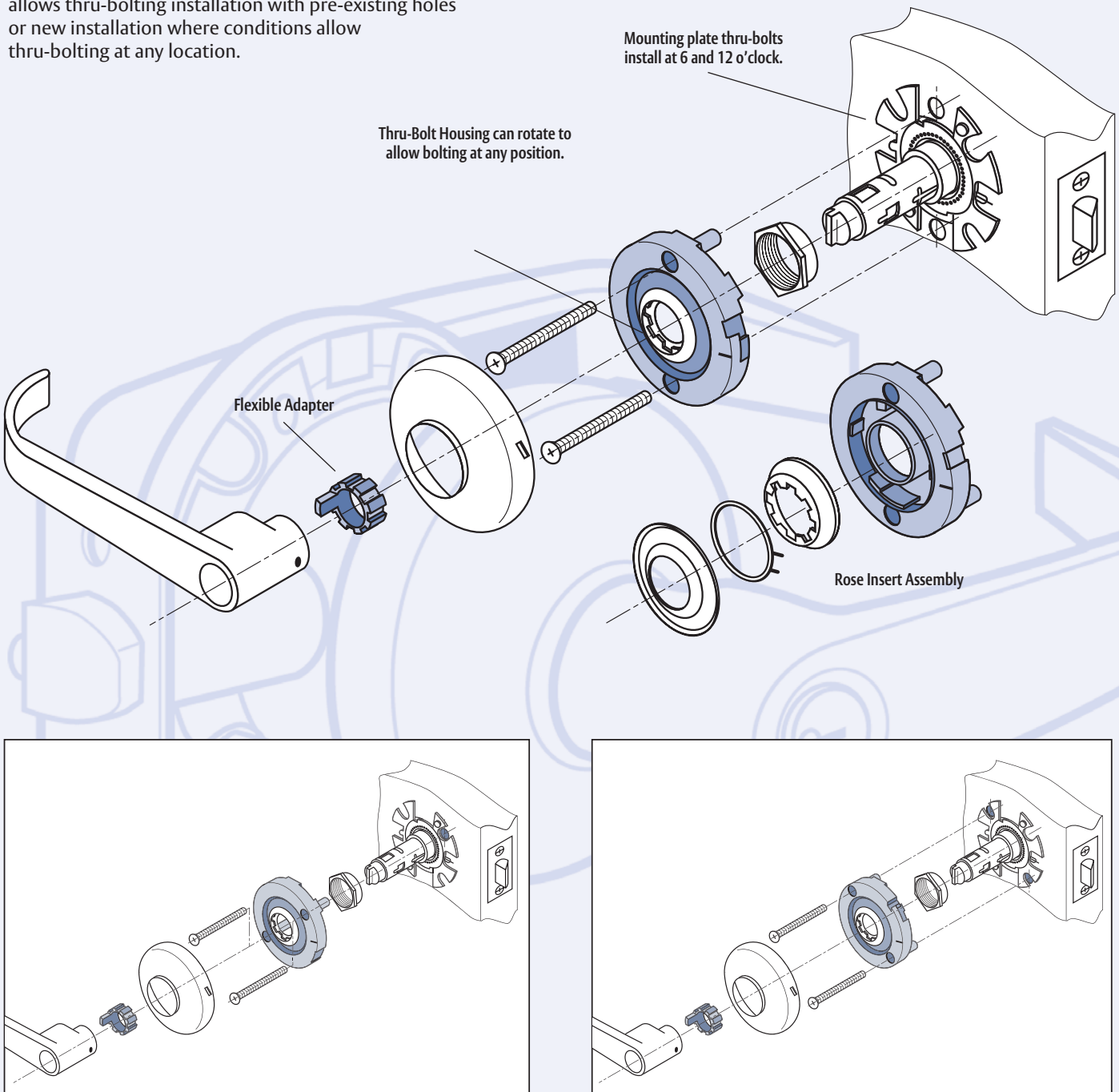

Q Series Cylindrical Lever

ASSA ABLOY, the global leader in door opening solutions



ASSA ABLOY

Electrical Lock:

Arrow electro-mechanical locksets can be integrated into life safety or security systems. Fail safe or fail secure options offer flexibility for most any application while meeting U.L. requirements for fire labeled doors.



Electrical Lock Functions:

SUFFIX	VOLTAGE*	CURRENT	RESISTANCE		DESCRIPTION
177	12VAC	250mA	51 ohms		FAIL SAFE: Power on locks outside lever. Inside lever always free. Latch retracted by key when locked electrically.
178	12VDC	250mA	51 ohms		
179	24VAC	150mA	165.5 ohms		
180	24VDC	150mA	165.5 ohms		
181	12VAC	250mA	51 ohms		FAIL SECURE: Power off locks outside lever. Inside lever always free. Latch retracted by key when locked electrically.
182	12VDC	250mA	51 ohms		
183	24VAC	150mA	165.5 ohms		
184	24VDC	150mA	165.5 ohms		

* Specify AC or DC







Q Series Cylindrical Lever

ASSA ABLOY, the global leader in door opening solutions

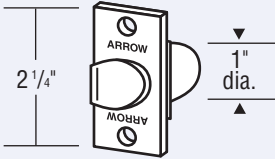
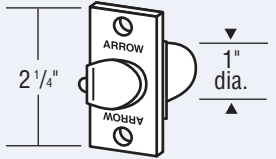
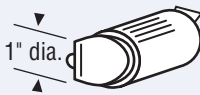
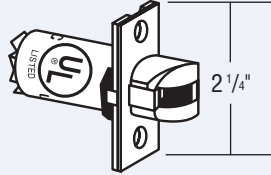

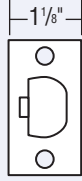

ASSA ABLOY

Latches:

Latches				
	1/2" throw, beveled	1/2" throw, beveled	1/2" throw	3/4" throw
	UL SPRING LATCH	UL DEAD LATCH	DRIVE-IN LATCH	UL FIRE DOOR LATCH
2-3/4" Backset	 #160	 #161	 #164	 #179
3-3/4" Backset	 #165	 #166	N/A	N/A

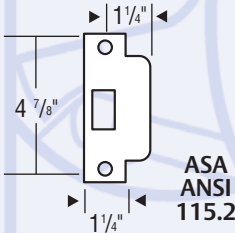
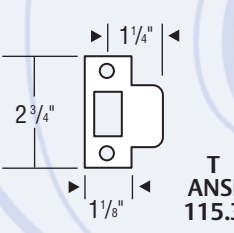
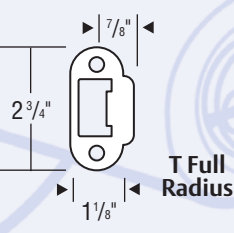
Strikes & Accessories:

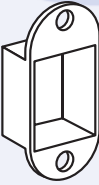
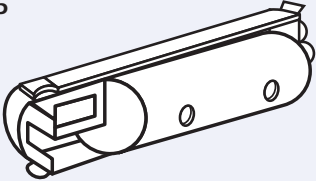
Strikes	#306	#320	#335
	 ASA ANSI 115.2	 T ANSI 115.3	 T Full Radius
Boxes	#BX70 	#BX10 	
Extension Links	#H25X5 		
	For 5" backset. Used in combination with #160 or #161 latch.		

Q Series Cylindrical Lever

Suggested Specification:

All locksets shall be Q Series heavy duty cylindrical locksets as supplied by Arrow Lock company.

Locksets shall meet ANSI/BHMA requirements for Series 4000, Grade 1 and shall be U.L. and c.U.L. listed for 3 hour, A label openings. In addition, locksets shall comply with ANSI A117.1 for barrier free accessibility and the California State Reference Code (formerly Title 19, California State Fire Marshall Standard) for levers returning to within 1/2" of the door surface.

Lockset shall be non handed. A single lock chassis shall accommodate a 1-3/4" doors. Lockset through bolting shall span the ANSI standard 2-1/8" door preparation. Through bolting shall be flexible and universal, allowing for installation in a variety of locations without removal of posts. Chassis mounting screws may be accessed only with the operating key in the cylinder to remove the lever and rose.

Lockset shall have heavy strength coil springs allowing lever handle to move bi-directionally. Lockset mounting plate shall interact with protrusions on locking nut to create secure locking between the two.

Lockset shall be equipped with OverDrive™, freewheeling feature whereby the latch retraction mechanism disengages from the lever handle allowing lever to move freely when locked. A built-in stop in the rose insert shall prevent lever from traveling beyond approximately 57 degrees.

Lever trim shall consist of cast levers with wrought brass or bronze rose scalps. Levers shall be a minimum of 4-5/8" in length and where applicable shall return to within 1/2" of the door surface.

Disassembly of lockset for cylinder removal shall not be required. Cylinder shall be changed by removing the lever.

How To Specify:

Example: To order a Q Series classroom function lockset with a Broadway design lever, satin chrome finish, with an ASA strike and 2-3/4" backset, keyed different:

Specify:

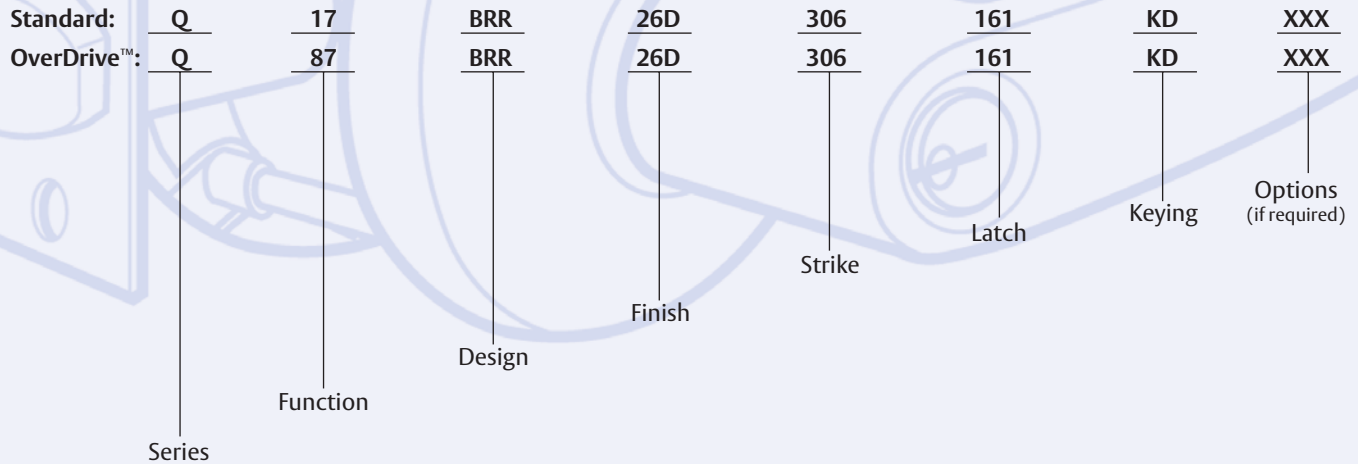

Q Series Cylindrical Lever

Arrow W Series Grade 1 heavy duty levers offer an economically pleasing solution for ADA compliance. They're offered in a complete range of functions and finishes and feature three lever designs that combine contemporary and traditional elements essential to the specifier, architect or facility manager.

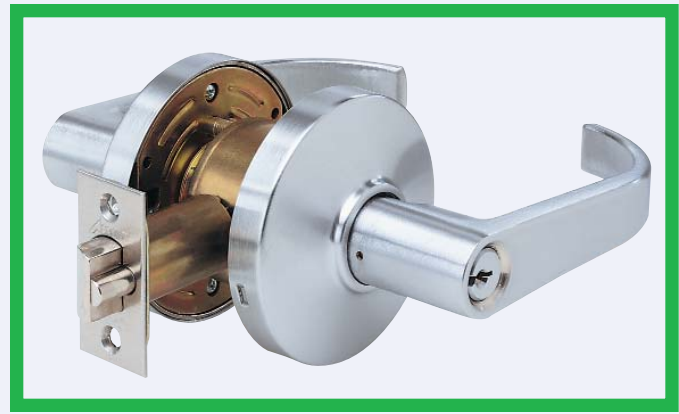

Certification:



All Arrow W Series locks are U.L. and c.U.L. listed for use on 3 hour, A label or lesser doors and are certified to conform to the requirements of ANSI/BHMA A156.2, Series 4000, Grade 1.

- Federal Specification FF-H-106C
- ANSI A117.1 Accessibility Code
- California State Reference Code for levers returning to within 1/2" (12.7mm) of door surface

Features:

Housing—Cold rolled steel, with zinc dichromated finish for rust resistance. Latch retractor is precision cast steel. Extended one piece bearing sleeve offers added support for interlocking stainless steel tubes and provides for extra lever rigidity.

Requires standard 2-1/8" (53.97mm) bore through door.

Thru-Bolts—Thru-bolted within standard 161 door preparation, which allows for easy retrofit without additional holes. Supplied with two support plates, which prevent lock from loosening when installed.



OverDrive™ will allow a locked lever to rotate freely without retracting the latch, improving the life and performance of Arrow locksets.

OverDrive™—Freewheeling lever action occurs when latch retraction mechanism disengages from lever handle when handle is locked. Built-in stops in the rose insert prevent lever from traveling beyond approximately 57 degrees. Additional 40% spring power in rose insert on OverDrive™ side of door ensures that lever handle returns to horizontal position.

Backset—2-3/4" (69.85mm) standard. 3-3/4" (95.25mm) and 5" (127mm) available.

Latch—Brass with 1/2" (12.7mm) throw standard. 3/4" (19.05mm) throw deadlocking firelatch is available for pairs of doors. Latch housing is steel, zinc dichromate finish for corrosion resistance. 1" (25.4mm) bore in edge of door is required.

ADA/Americans with Disabilities Act:

Acceptable Door Hardware: Section 4.13.9

Handles, pulls, latches and other operating devices on accessible doors shall have a shape that is easy to grasp with one hand and does not require grasping, tight pinching or twisting of the wrist to operate. Lever operated mechanisms, push-type mechanisms and "U" shaped handles are acceptable designs.

 Look for the universal symbol next to Arrow products that comply with ADA accessibility requirements.

Latch Front—Brass, bronze or stainless steel.

2-1/4" (57.15mm) x 1-1/8" (28.57mm) beveled, 1/8" (3.175mm) in 2" (50.8mm).

Exposed Trim—Levers are pressure cast zinc. Streamline rose scalp of brass or bronze complements other series of lever locks.

Rose Inserts—Contain coil spring which is a permanent assembly within rose insert. The inside insert has graduating steps in two locations to prevent rose scalp from loosening. A "catch" on the outside insert prevents rose scalp from working itself loose during installation.

Strikes—Brass, bronze or stainless steel. ANSI A115.2, 4-7/8" (123.82mm) x 1-1/4" (31.75mm) curved lip strike standard. Optional 2-3/4" (69.85mm) x 1-1/8" (28.57mm) strike available. All strikes have 1-1/4" (31.75mm) lip to center dimension.

Door Thickness—1-3/4" (44.45mm).

Handing—Non-handed. Levers operate bi-directionally.

Finishes—US3,US4,US10,US10B,US26,US26D. Consult factory for the availability of other non-listed finishes.

Packaging—1 per box, 10 per case.

Warranty—Limited three year warranty.

W Series Cylindrical Lever

Designs:

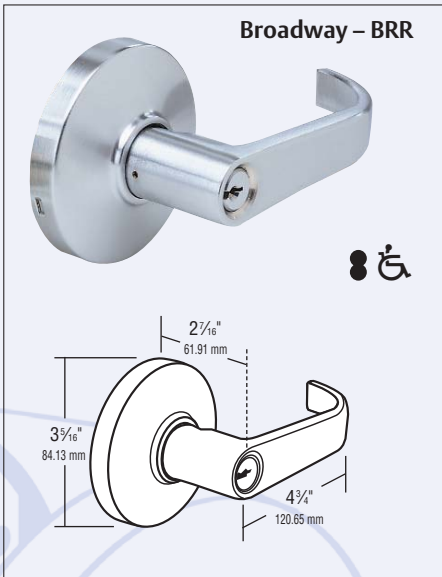
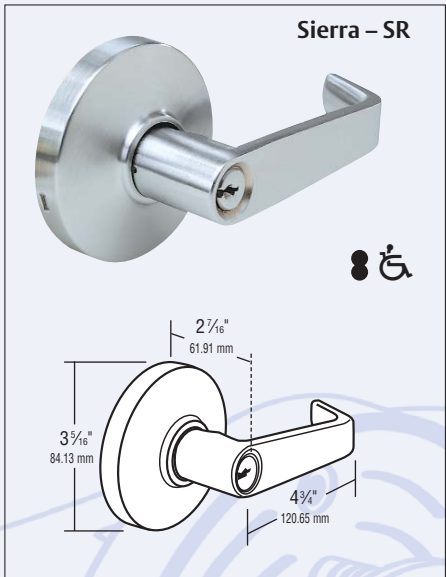

Finishes:



	BHMA	U.S. Equivalent	Arrow Equivalent	Finish
1	605	US3	03	Bright Brass
2	606	US4	04	Satin Brass
3	612	US10	10	Satin Bronze
4	613	US10B	10B	Dark Oxide Bronze, Oil Rubbed
5	625	US26	26	Bright Chromium Plated
6	626	US26D	26D	Satin Chromium Plated

Cylinders:

Conventional—W Series locksets are supplied standard with Arrow “A” keyway, 6 pin cylinder. As with all other lock series, various levels of masterkeying are available. Conventional cylinders are available in a variety of competitive manufacturers keyways. Supplied with two nickel silver keys.



Cylinder Options—Interchangeable core/flex-core – lockset prepared for use with 6 or 7 pin interchangeable core. Supplied less core, but packed with 6 and 7 pin tailpieces. Will accept cores manufactured by Arrow, Best™, Falcon™, Medeco Keymark™ and others. Suffix “IC” to design. Temporary Arrow construction cores are also available.

Interchangeable Core:

Look for this symbol to indicate availability of product with interchangeable core.

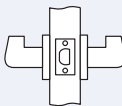
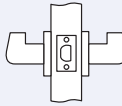
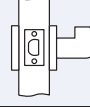
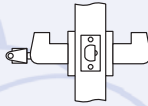
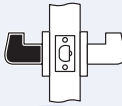
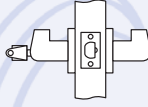
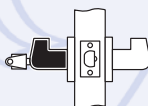
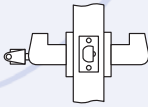
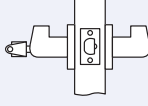

W Series Cylindrical Lever

Functions:

ARROW STANDARD	ARROW OVERDRIVE™	ANSI/FEDERAL #	FUNCTION	DESCRIPTION
W01		F75/161N	Passage	 Latchbolt operated by lever either side.
W02	W72	F76/161L	Privacy	 Latchbolt operated by lever either side except when inside pushbutton locks outside lever. Unlocked by turning inside lever, using emergency key outside or closing door.
W03			Communicating	 Latchbolt by inside lever only. Blank rose only outside.
W06	W76		Hospital Privacy	 Latchbolt operated by lever either side except when inside pushbutton locks outside lever. Unlocked from outside by key "trapped" in outside lever. Turning inside lever or closing door will also unlock outside lever.
W07	W77	F89/161NX	Exit	 Latchbolt operated by inside lever only. Outside lever always rigid.
W11	W81	F81/161A	Entrance/Office	 Latchbolt operated by lever either side except when outside lever is locked by turn-button inside. When outside lever is locked, latchbolt operated by key outside or turning inside lever. Pushing and turning inside button will cause outside lever to remain locked. Button will then need to be manually rotated to unlock outside lever.
W12	W82	F86/161D	Storeroom	 Latchbolt operated by key in outside lever or by inside lever. Outside lever always rigid.
W13	W83	F82/161B	Exterior	 Latchbolt operated by lever from either side except when outside lever is locked by push-button inside. Outside lever remains locked until unlocked by key or turning inside lever.
W14	W84	F92/161E	Service Station	 Latchbolt operated by lever either side except when slotted pushbutton inside locks outside lever. Outside lever unlocked by turning inside lever or closing door. When slotted button is pushed and turned, outside lever is rigid and is unlocked either by key outside or turning inside lever. Inside lever always free.
				Indicates lever rigid at all times.

W Series Cylindrical Lever

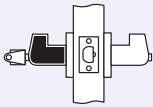
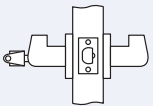
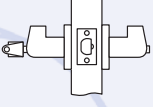
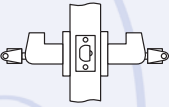
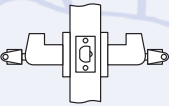
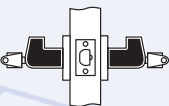
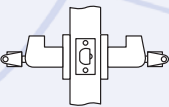
Functions:

ARROW STANDARD	ARROW OVERDRIVE™	ANSI/FEDERAL #	FUNCTION		DESCRIPTION
W15	W85	F93/161H	Hotel		Latchbolt operated by inside lever at all times. Outside lever rigid at all times. Key outside will retract latch except when pushing inside button shuts out all keys except emergency key and activates visual occupancy indicator on face of cylinder. Turning inside lever or closing door releases button and retracts visual indicator. Turning inside button with spanner key will lock button in fixed position. Button then released with spanner or emergency key.
W17	W87	F84/161R	Classroom		Latchbolt operated by lever either side except when key outside locks outside lever. Inside lever always free. Key outside locks/unlocks outside lever only.
W19	W89	F90/161T	Dormitory		Latch operated by lever either side except when outside lever is locked by key outside or by pushbutton inside. Key outside locks or unlocks outside lever. Unlocked by turning inside lever, closing door or using key outside.
W31	W91	F80/161S	Communicating		Latchbolt operates by lever either side. Key in either lever locks its own lever independently. Not recommended for use in rooms with no other entrance.
W32	W92	F88/161C	Public Entrance		Latchbolt operated by lever from either side except when key from inside lever locks outside lever. When outside lever is locked, latchbolt retracted by key in outside lever or by turning inside lever.
W33	W93	F87/161W	Asylum		Latchbolt operated by key in either lever. Both levers always rigid.
W35	W95	F91/161G	Exterior		Latchbolt operated by lever either side except when both levers are locked by key from either side.
					Indicates lever rigid at all times.

W Series Cylindrical Lever

Latches & Strikes:

Latches

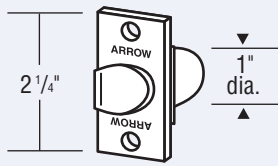

1/2" throw, beveled

SPRING LATCHES

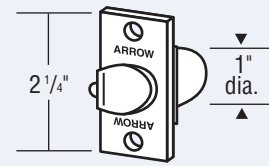

1/2" throw, beveled

DEAD LATCHES

2-3/4" Backset



#160, U.L.

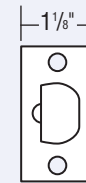

#161, U.L.

Accessories:

Strikes

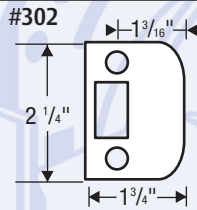

#302

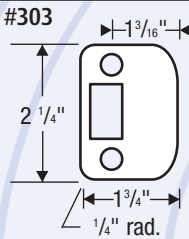

#303

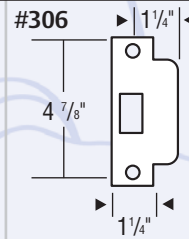

#306

ASA
ANSI
115.2

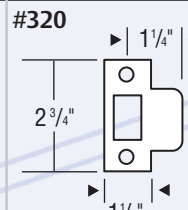

#320

T
ANSI
115.3

Boxes

#BX70



#BX10

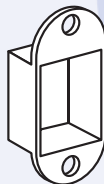

W Series Cylindrical Lever

ASSA ABLOY, the global leader
in door opening solutions



ASSA ABLOY

Suggested Specification:

All locksets shall be W Series Cylindrical locksets as supplied by Arrow Lock company.

Locksets shall meet ANSI/BHMA requirements for Series 4000, Grade 1, and shall be U.L. and c.U.L. listed for 3 hour, A label openings. Lockset conforms to ANSI A117.1 for barrier-free accessibility, and the California State Reference Code (formerly Title 19, California State Fire Marshall Standard).

Lockset shall be non-handed. Lockset shall have anti-rotation support plates and no exposed screws. Chassis mounting screws may be accessed only when lever and rose are removed.

Inside and outside rose inserts shall have independent heavy strength coil springs allowing lever handle to move bi-directionally.

Lockset shall be equipped with OverDrive™, freewheeling feature whereby the latch retraction mechanism disengages from the lever handle allowing lever to move freely when locked, without retraction the latch. A built in stop in the rose insert shall prevent lever from travelling beyond approximately 57 degrees.

Lever trim shall consist of cast levers with wrought brass or bronze rose scalps. Levers shall be a minimum of 4-5/8" in length and where applicable shall return to within 1/2" of the door surface.

Disassembly of lockset for cylinder removal shall not be required. Cylinder shall be changed by removing the lever.

All products shall be of one manufacturer and shall comply with Federal Acquisition Regulations (FAR) for products made in the U.S.A.

All locksets shall carry a three year limited warranty.

How To Specify:

Example: To order a W Series classroom function lockset with a Broadway design lever, satin chrome finish, with an ASA strike and 2-3/4" backset, keyed different:

Specify:

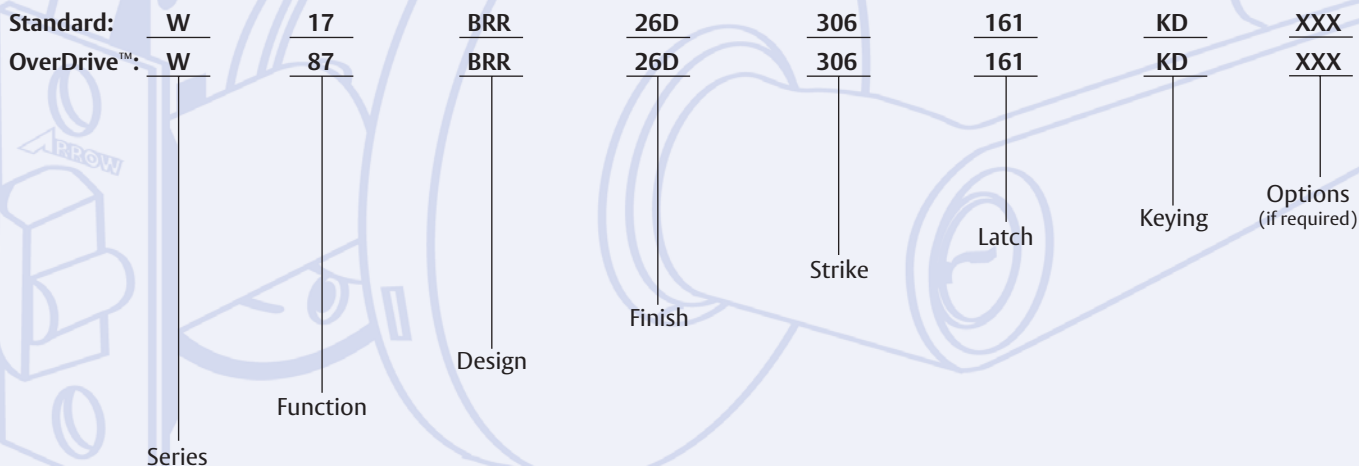

Installation:

161 prep for retrofit and secure installation.

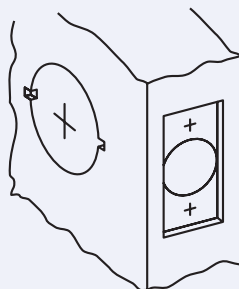

W Series Cylindrical Lever

Arrow Patented ML Series levers offer the designer, architect and contractor simple solutions to accessibility requirements. Their clean designs, architectural finishes and available functions make them ideal for commercial applications where heavy duty grade one hardware may not be necessary.

US Patent #5, 149, 155

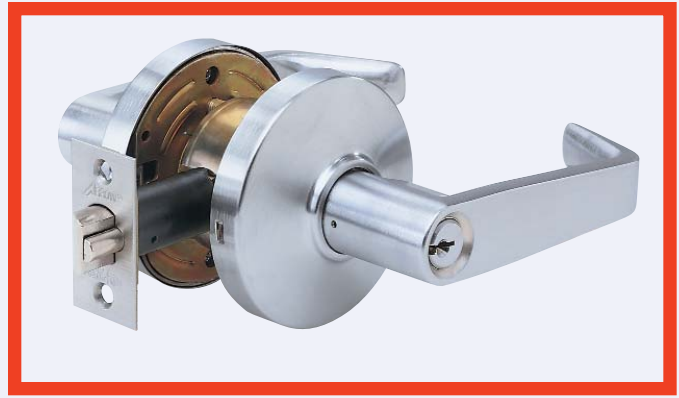

Certification



All Arrow ML Series locks are U.L. and c.U.L. listed for use on 3 hour, A label or lesser doors and are certified to conform to the requirements of ANSI/BHMA A156.2, Series 4000, Grade 2.

- Federal Specification FF-H-106C
- ANSI A117.1 Accessibility Code
- California State Reference Code for levers returning to within 1/2" (12.7mm) of door surface.

General Specifications

Housing—Cold rolled steel, with zinc dichromated finish for rust resistance. Latch retractor is precision cast zinc. Extended one piece bearing sleeve offers added support for interlocking stainless steel tubes and provides for extra lever rigidity. Requires standard 2-1/8" (53.97mm) bore through door.

Thru-Bolts—Patented thru-bolt design allows for thru-bolting within standard 161 door preparations, which allows for easy retrofit without additional holes. Supplied with two support plates, which secure to face of door as well as accept thru-bolts from inside rose assembly.



OverDrive™ will allow a locked lever to rotate freely without retracting the latch, improving the life and performance of Arrow locksets.

OverDrive™—Freewheeling lever action occurs when latch retraction mechanism disengages from lever handle when lever is locked. Built-in stops in the rose insert prevent lever from traveling beyond approximately 57 degrees. Additional 40% spring power in rose insert on OverDrive™ side of door ensures that lever handle return to the horizontal position.

Latch—Brass with 1/2" (17.7mm) throw. Latch housing is steel, zinc dichromate finish for corrosion resistance. 7/8" (22.225mm) bore in edge of door is required. Supplied with #K-179 sleeve for use with existing 1" (25.4mm) edge bore.

ADA/Americans with Disabilities Act

Acceptable Door Hardware: Section 4.13.9

Handles, pulls, latches and other operating devices on accessible doors shall have a shape that is easy to grasp with one hand and does not require grasping, tight pinching or twisting of the wrist to operate. Lever operated mechanisms, push-type mechanisms and "U" shaped handles are acceptable designs.



Look for the universal symbol next to Arrow products that comply with ADA accessibility requirements.

Latch Front—Brass, bronze or stainless steel. 2-1/4" (57.15mm) x 1-1/8" (28.57mm). Available with 1" (25.4mm) front latch for 2-3/8" (60.32mm) backset or 1" front for 2-3/4" (69.85mm) backset.

Exposed Trim—Levers are pressure cast zinc. Streamline rose scalp of brass or bronze complement other series of lever locks.

Rose Insert—Contain coil springs, which are permanent assemblies within rose inserts. The inside insert has graduating steps in two locations to prevent the rose scalp from loosening. A catch on the outside insert prevents rose scalp from working itself loose during installation.

Strikes—Brass, bronze or stainless steel. ANSI A115.2, 4-7/8" (123.82mm) x 1-1/4" (31.75mm) curved lip strike. Optional 2-3/4" (69.85mm) x 1-1/8" (28.57mm) strike is available. All strikes have 1-1/4" (31.75mm) lip to center dimension.

Backset—2-3/4" (69.85mm) standard, 3-3/4" (95.25mm) available. Also available with 5" (127mm) backset when used in conjunction with Grade 1 latch.

Door Thickness—1-3/8" (34.92mm) to 1-3/4" (44.45mm) standard.

Handing—Non-handed.

Finishes—US3, US4, US10, US10B, US26, US26D. Consult factory for the availability of other non-listed finishes.

Packaging—1 per box, 10 per case.

Warranty—Limited three year warranty.

ML Series Cylindrical Levers

Designs

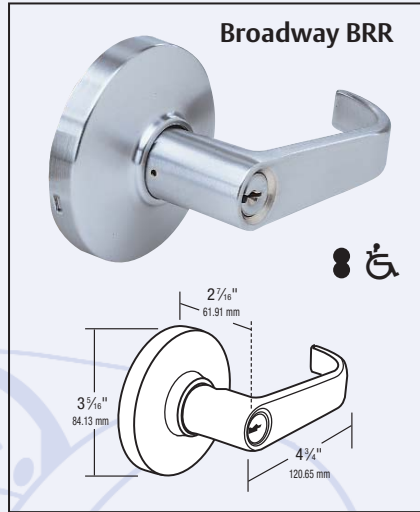
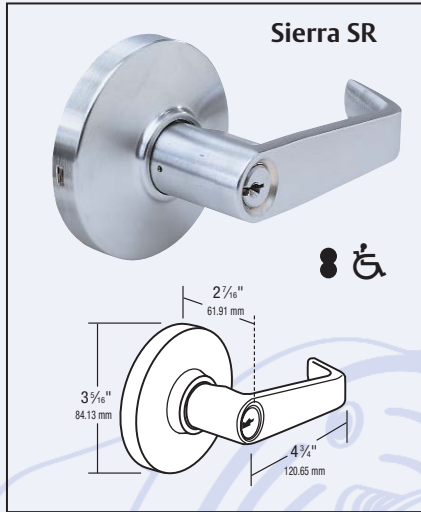

Finishes



	BHMA	U.S. Equivalent	Arrow Equivalent	Finish
1	605	US3	03	Bright Brass
2	606	US4	04	Satin Brass
3	612	US10	10	Satin Bronze
4	613	US10B	10B	Dark Oxide Bronze, Oil Rubbed
5	625	US26	26	Bright Chromium Plated
6	626	US26D	26D	Satin Chromium Plated

Cylinder Options





Conventional—ML Series locksets are supplied standard with Arrow “A” keyway, 6 pin cylinder. As with all other lock series, various levels of masterkeying are available. Conventional cylinders are available in a variety of competitive manufacturers keyways. Supplied with two nickel silver keys.

Interchangeable Core—Lockset prepared to use with 6 or 7 pin interchangeable core. Supplied less core, but packed with tailpiece. Will also accept cores manufactured by Best™, Falcon™, Medeco Keymark™, ASSA™, and others. Suffix “IC” to indicate small format interchangeable core, or “LIC” (SR design only) to indicate Medeco or ASSA High Security large format interchangeable core. Temporary Arrow small format construction cores are also available.

Interchangeable Core

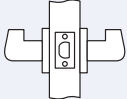
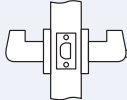
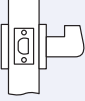
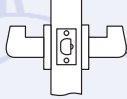
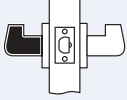
Look for this symbol to indicate availability of product with interchangeable core design.

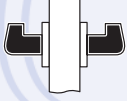
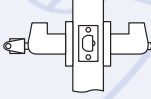
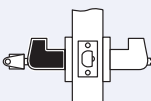
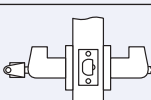
ML Series Cylindrical Levers

Arrow Standard	Arrow Overdrive	ANSI#	Function		Description
ML01		F75	Passage		Latch bolt operated by lever, from either side at all times.
ML02	ML72	F76	Privacy		Latch bolt operated by lever from either side. Outside lever is locked by push button inside and unlocked by emergency release outside, operating inside lever or closing door.
ML03		F111	Communicating		Dead locking latch bolt operated by lever one side only at all times. Non removable blank trim outside.
ML06	ML76	F76	Hospital Privacy		Latch bolt operated by lever from either side. Outside lever is locked by push button inside and unlocked by using coin outside, operating inside lever or closing door.
ML07	ML77	F89	Exit		Dead locking latch bolt retracted by lever from inside at all times. Outside lever is always inoperable.
ML08			Single Dummy Trim		Rigid trim for one side of door only. Used as pull or to match active trim.
ML09			Full Dummy Trim		Rigid trim for both sides of door. Used as pulls or to match active trim.
ML11	ML81	F109 (F81 & F82)	Entrance/Office		Dead locking latch bolt operated by lever from either side except when outside lever is locked by pushing turn button inside. Key outside or operating inside lever releases turn button unlocking outside lever except when turn button had been rotated to keep outside lever locked. Inside turn button must be manually operated to unlock outside lever. Inside lever always operates latch bolt.
ML12	ML82	F86	Storeroom		Dead locking latch bolt operated by key in outside lever, or by operating inside lever. Outside lever is always inoperable.
ML13	ML83	F82	Exterior		Dead locking latch bolt operated by lever from either side except when outside lever is locked by push button inside. When outside lever is locked, operating key in outside lever or operating inside lever unlocks push button and retracts latch bolt. Closing door does not release push button.
					Indicates lever rigid at all times.

ML Series Cylindrical Levers

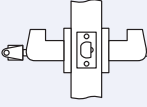
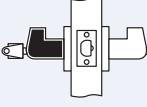
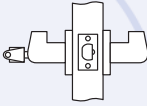
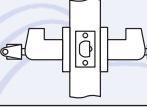
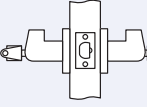
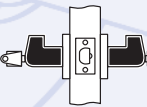
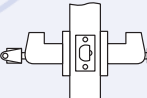
Arrow Standard	Arrow Overdrive	ANSI#	Function		Description
ML14	ML84	F92	Service Station		Dead locking latch bolt operated by lever from either side except when outside lever is locked by push button inside. Key outside, operating inside lever or closing door releases push button unlocking outside lever except when slotted push button is in a locked position. Inside lever always operates latch bolt.
ML15	ML85	F93	Hotel		Dead locking latch bolt operated by lever from inside at all times. Outside lever always inoperable. Latch bolt operated by key from outside except when push button inside is operated thus shutting out all keys except emergency key. Operating push button operates outside visual indicator showing room is occupied. Operating inside lever or closing door releases indicator and shut out feature except when shut out is activated by turning inside button with spanner key which shuts out all keys except emergency key.
ML17	ML87	F84	Classroom		Dead locking latch bolt operated by lever from either side except when outside lever is locked from outside by key. When outside lever is locked, latch bolt is operated by inside lever.
ML31	ML91	F80	Communicating		Dead locking latch bolt operated by lever from either side. Turning key in either lever locks or unlocks its own lever independently. Do not use on doors in rooms that have no other entrance.
ML32	ML92	F88	Public Entrance		Dead locking latch bolt operated by lever from either side except when outside lever is locked by key from inside. When outside lever is locked, latch bolt is retracted by key in outside lever or by operating inside lever.
ML33	ML93	F87	Asylum		Dead locking latch bolt operated by key in lever, from either side. Both levers always inoperable.
ML35	ML95	F91	Exterior		Dead locking latch bolt operated by lever from either side except when both levers are locked by key from either side.

ML Series Cylindrical Levers

ASSA ABLOY, the global leader
in door opening solutions



ASSA ABLOY

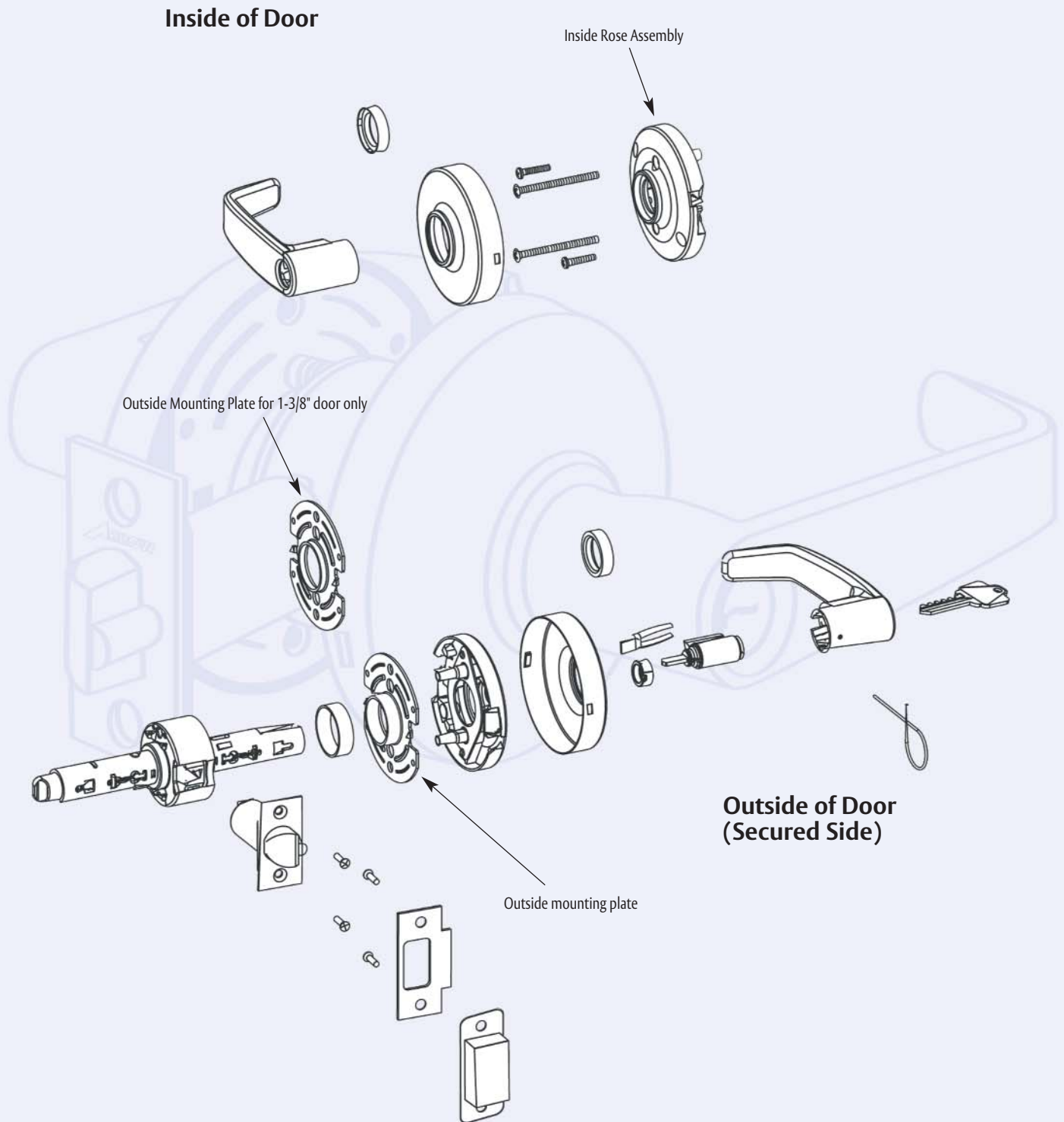

ML Series Cylindrical Levers

ASSA ABLOY, the global leader
in door opening solutions



ASSA ABLOY

Latches & Strikes

Latches

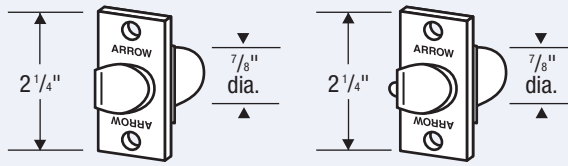

Latch Standards

UL Spring Latches

UL Dead Latches

Strikes

2-3/8" Backset

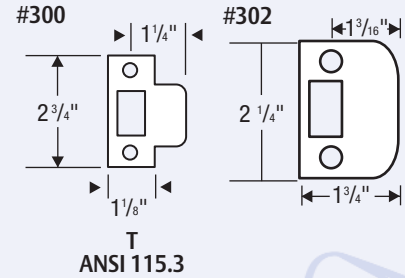
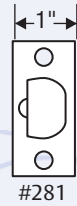

2-3/4" Backset

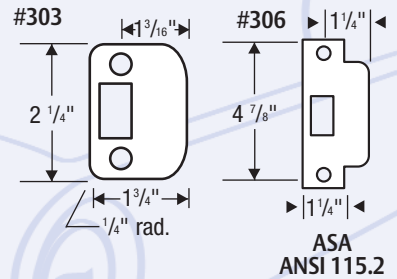

3-3/4" Backset

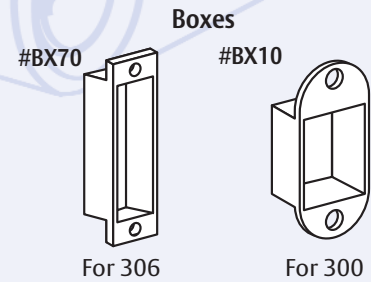
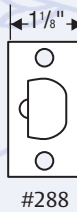

Latch Options: #272 - 2-3/4" backset 1" x 2-1/4" #282 - 2-3/4" backset 1" x 2-1/4"

Accessories

Extension Link Sleeve

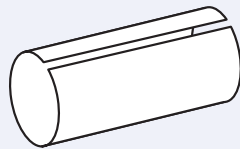

1050-179

Extension Link

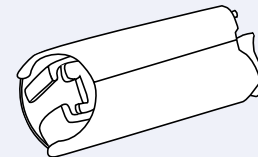

H25: For 5" backset used in conjunction with 160 or 161 latch. (consult price book for ordering information)

ML Series Cylindrical Levers

Suggested Specification

All locksets shall be ML Series Cylindrical locksets as supplied by Arrow Lock company.

Locksets shall meet ANSI/BHMA requirements for Series 4000, Grade 2, and shall be U.L. and c.U.L. listed for 3 hour, A label openings. Lockset conforms to ANSI A117.1 for barrier-free accessibility, and the California State Reference Code (formerly Title 19, California State Fire Marshall Standard).

Lockset shall be non-handed. Lockset shall have anti-rotation support plates which secure to face of door and accept internal thru-bolts. Lockset shall have no exposed screws. Chassis mounting screws may be accessed only when lever and rose are removed.

Inside and outside rose inserts shall have independent heavy strength coil springs allowing lever handle to move bi-directionally.

Lockset shall be equipped with OverDrive™, freewheeling feature whereby the latch retraction mechanism disengages from the lever handle allowing

lever to move freely when locked, without retraction the latch. A built-in stop in the rose insert shall prevent lever from traveling beyond approximately 57 degrees.

Lever trim shall consist of cast levers with wrought brass or bronze rose scalps. Levers shall be a minimum of 4-5/8" in length and where applicable shall return to within 1/2" of the door surface.

Disassembly of lockset for cylinder removal shall not be required. Cylinder shall be changed by removing the lever.

All products shall be of one manufacturer and shall comply with Federal Acquisition Regulations (FAR) for products made in the U.S.A.

All locksets shall carry a three year limited warranty.

How To Specify

Example: To order a ML Series classroom function lockset with a BB design, satin chrome finish, with an ASA strike and 2-3/4" backset, keyed different:

Specify:

Standard:

ML 17 BRR 26D 306 284 KD XXX

Overdrive™:

ML 87 BRR 26D 306 284 KD XXX

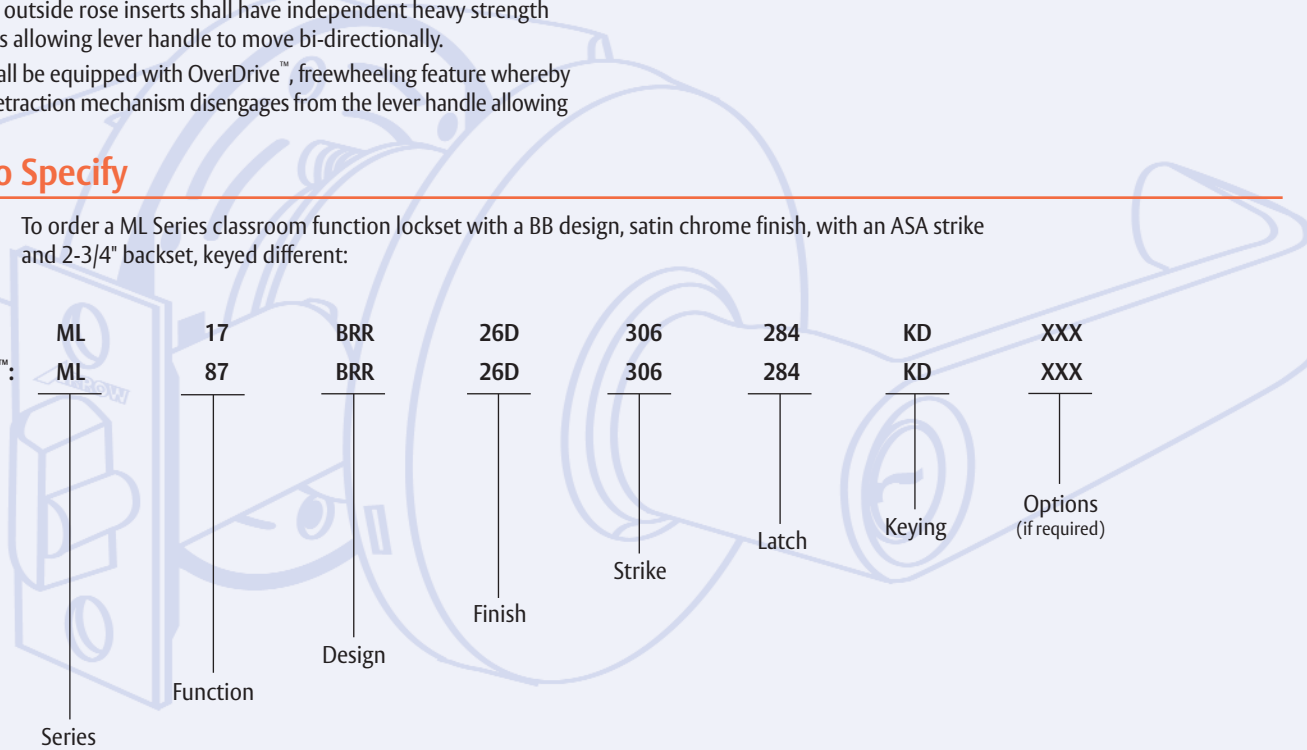

Installation

161 prep for retrofit and secure installation.

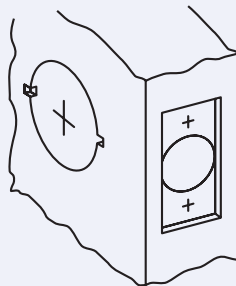

ML Series Cylindrical Levers

ASSA ABLOY, the global leader in door opening solutions



ASSA ABLOY

Arrow's L Series Grade 2 cylindrical lever lock provides an economical solution to accessibility requirements. It is ideal for commercial applications where heavy-duty grade levers may not be required.



Certification:



All Arrow L Series locks are U.L. and c.U.L. listed for use on 3 hour, A label or lesser doors and are certified to conform to the requirements of ANSI/BHMA A156.2, Series 4000, Grade 2.

- Federal Specification FF-H-106C
- ANSI A117.1 Accessibility Code
- California State Reference Code for levers returning to within 1/2" (12.7mm) of door surface

Features:

Housing—Cold rolled steel, with zinc dichromated finish for rust resistance. Requires standard 2-1/8" (53.97mm) bore through door.

Latch—Brass or bronze with 1/2" (12.7mm) throw. Latch housing is steel, zinc dichromate finish for corrosion resistance.

Latch Front—Brass or bronze 2-1/4" (57.15mm) x 1-1/8" (28.57mm) beveled UL latches are standard. Available with 1" flat fronts for 2-3/8" backset, or 1" beveled fronts for 2-3/4" backset.

Exposed Trim—Levers are pressure cast zinc, measuring 4" in length. Roses are wrought brass or bronze with a 3-5/16" diameter. Total projection from face of door is 2-7/16".

Handing—Non-handed.

Strikes—Brass, bronze or stainless steel. #300 and #306 strikes measure 1-1/4" curved lip to center. #302 and #303 strike measure 1-3/16" lip to center dimension. Strike boxes are available.

Finishes:

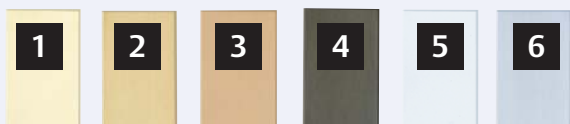

	BHMA	U.S. Equivalent	Arrow Equivalent	Finish
1	605	US3	03	Bright Brass
2	606	US4	04	Satin Brass
3	612	US10	10	Satin Bronze
4	613	US10B	10B	Dark Oxide Bronze, Oil Rubbed
5	625	US26	26	Bright Chromium Plated
6	626	US26D	26D	Satin Chromium Plated

Cylinders:

Conventional—L Series locksets are supplied standard with Arrow "A" keyway, 6 pin. As with all other lock series, all levels of masterkeying are available.

ADA/Americans with Disabilities Act:

Acceptable Door Hardware: Section 4.13.9

Handles, pulls, latches and other operating devices on accessible doors shall have a shape that is easy to grasp with one hand and does not require grasping, tight pinching or twisting of the wrist to operate. Lever operated mechanisms, push-type mechanisms and "U" shaped handles are acceptable designs.



Look for the universal symbol next to Arrow products that comply with ADA accessibility requirements.

Backset—2-3/4" (69.85mm) backset standard; 2-3/8" (60.32mm) available.

Door Thickness—1-3/8" to 1-3/4" thick. (Supplied with four mounting plates).

Cylinders—Brass, 6 pin, Arrow "A" keyway standard. Competitive keyways are also available.

Finishes—US3,US4,US10,US10B,US26,US26D. Consult factory for the availability of other non-listed finishes.

Packaging—1 per box, 12 per case.

Competitive Keyways

Arrow	Equivalent
CS	Schlage C
ES	Schlage E
PS*	Schlage F*
D1	Russwin D1

* Composite keyway

Competitive Keyways

Arrow	Equivalent
8	Yale 8
60	Corbin 60
LA	Sargent LA

L Series Cylindrical Levers

Designs

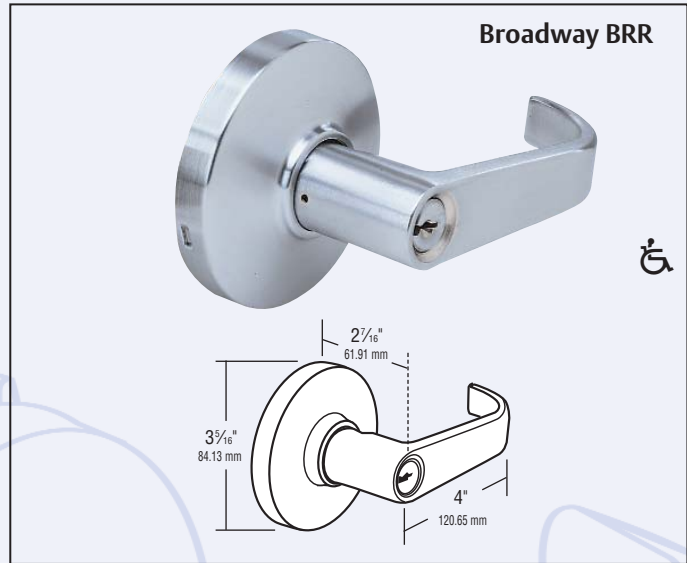
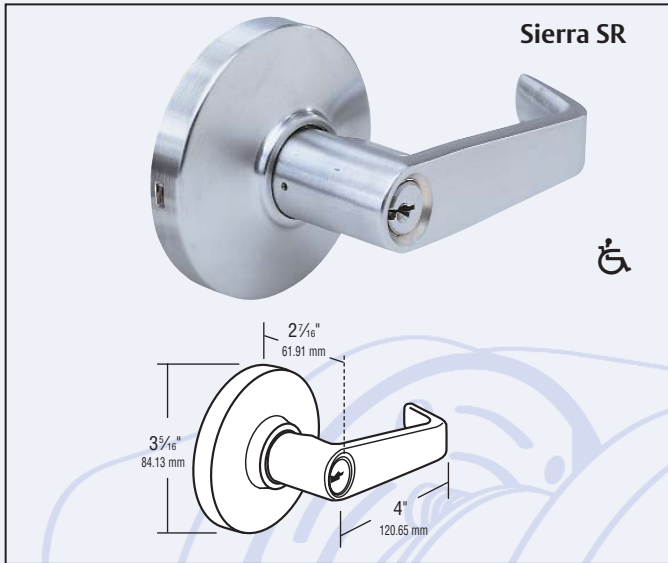

Functions:

ARROW Standard	ANSI #	Function	Description
01	F75	Passage	Latch by lever either side.
02	F76	Privacy	Latch by lever either side except when inside push button locks outside lever. Unlocked by turning inside lever, closing door or turning outside emergency slot.
08 09		Dummy Pull Only	Dummy trim (single). Dummy trim (double).
11	F81	Entrance & Office Doors	Latch by lever either side except when pushing turn-button locks outside lever. Unlocked by turning inside lever or using key outside. Pushing and turning inside button keeps outside lever locked. Key will retract latch.
12	F86	Storeroom & Closet Doors	Latch by inside lever. Outside Lever always rigid. Key will retract latch.
17	F84	Classroom Doors	Latch by lever either side except when key locks outside lever. Key will unlock lever.

L Series Cylindrical Levers

Latches & Strikes:

Latches

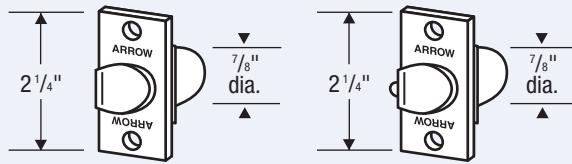

Latch Standards

UL Spring Latches

UL Dead Latches

Strikes

2-3/8" Backset

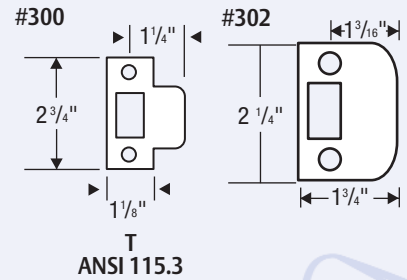
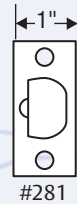

2-3/4" Backset

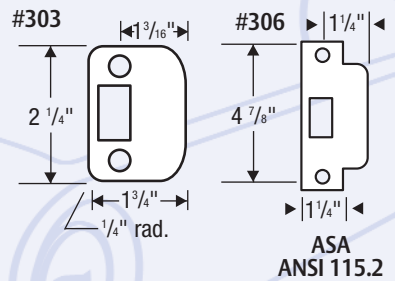

3-3/4" Backset

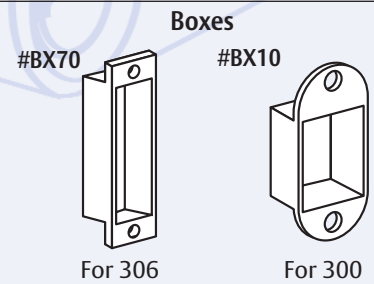
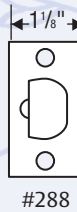

Latch Options: #272 - 2-3/4" backset 1" x 2-1/4" #282 - 2-3/4" backset 1" x 2-1/4"

Accessories:

Extension Link Sleeve

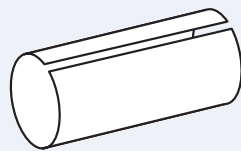

1050-179

Extension Link

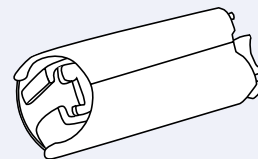

H25: For 5" backset used in conjunction with 160 or 161 latch. (consult price book for ordering information)

L Series Cylindrical Levers

Suggested Specification:

All locksets shall be L Series standard duty cylindrical locksets as supplied by Arrow Lock company.

Locksets shall meet ANSI/BHMA requirements for Series 4000, Grade 2, and shall be U.L. listed for 3 hour, A label openings. In addition, locksets shall comply with ANSI A117.1 for barrier-free accessibility, and the California State Reference Code (formerly Title 19, California State Fire Marshall Standard).

Lockset shall be non-handed. A single lock chassis shall accommodate both 1-3/8" to 1-3/4" doors. Locksets shall be thru-bolted within standard door preparation and shall have anti-rotation support plates and no exposed screws. Chassis mounting screws may be accessed only when lever and rose are removed.

Exposed lock trim shall consist of solid cast levers, with no plastic inserts and wrought brass or bronze roses. Inside and outside sub-rose assemblies shall contain independent springs to prevent lever sag. Levers shall operate independently. Lever shall be a minimum of 4" in length and have a return that comes to within 1/2" of the door surface.

Cylinders shall be brass. A single lockset shall accommodate 5 or 6 pin conventional cylinders with all levels of master keying.

All products shall be of one manufacturer.

All locksets shall carry a one year limited warranty.

How To Specify:

Example: To order an L Series classroom function lockset with a Broadway design lever, satin chrome finish, with an ASA strike and 2-3/4" backset, keyed different:

Specify:

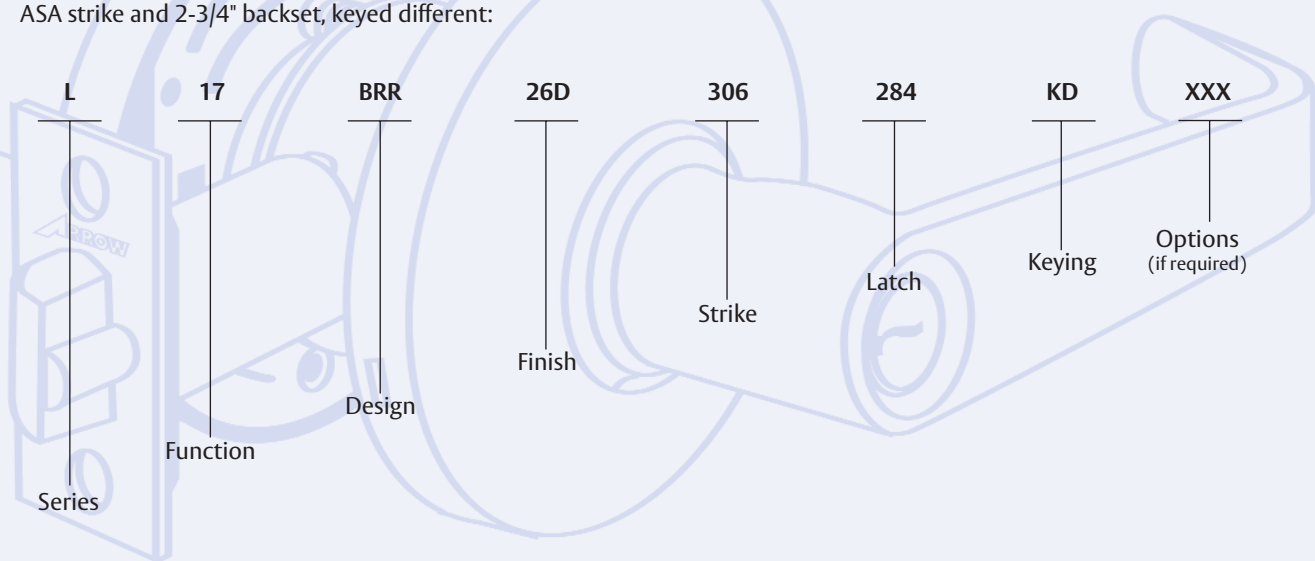

L Series Cylindrical Levers

ASSA ABLOY, the global leader
in door opening solutions



ASSA ABLOY

The RL Series has been enhanced to offer removable throughbolts and a wide variety of designs, finishes and functions. The RL Series cylindrical locksets are an economical value for a variety of application. Perfect for multi-family housing markets, as well as light commercial applications.



Certification

The RL Series has been designed to meet the requirements of ANSI, A156.2, Series 4000, Grade 2 UL Listed for use on 3 hour, A label single swinging doors.

RL Levers conform to ADA requirements.

ADA/Americans with Disabilities Act

Acceptable Door Hardware: Section 4.13.9

Handles, pulls, latches and other operating devices on accessible doors shall have a shape that is easy to grasp with one hand and does not require grasping, tight pinching or twisting of the wrist to operate. Lever operated mechanisms, push-type mechanisms and "U" shaped handles are acceptable designs.

Look for the universal symbol next to Arrow products that comply with ADA accessibility requirements.

Features

Construction – Cold rolled steel with zinc dichromate finish for corrosion resistance. Requires standard 2-1/8" (53.97mm) bore through door.

Backset – 2-3/8" (60.31mm) or 2-3/4" (69.85mm)

Door Thickness – Fits 1-3/8" (34.93mm) to 1-3/4" (44.45mm) doors standard.

Latch – Brass 1/2" (12.7mm) throw, UL Listed, guarded latchbolt on all locking functions

Latch Front – 1" x 2-1/4" (25.40mm x 57.15mm) for 2-3/8" backset (60.32mm) or 1-1/8" x 2-1/4" for 2-3/4" (69.85mm) backset.

Exposed Trim – RL Levers are pressure cast zinc measuring 4-3/4" (120.65mm) in length. RL Roses are wrought brass 3-3/8" (85.73mm) diameter. Total projection from face of door is 2-1/2" (63.5mm).

Strike – 4-7/8" ANSI (123.83mm), 2-3/4" (69.85mm) T strike, or 2-1/4" (57.15mm) full lip strike.

Cylinder – Solid brass 6 pin. Arrow "A" keyway standard. C keyway optional.

Keys – 2 brass keys

Handing – Non-handed

Thru-bolts – Removable thru-bolts standard on RL Series

Packaging – 10 per case

Warranty – Five Year Mechanical Warranty

Finishes:

RK is available in 03, 04, 10, 10B, 32 and 32D.



	BHMA	U.S. Equivalent	Arrow Equivalent	Finish
1	605	US3	03	Bright Brass
2	606	US4	04	Satin Brass
3	612	US10	10	Satin Bronze
4	613	US10B	10B	Dark Oxide Bronze, Oil Rubbed
5	625	US26	26	Bright Chromium Plated
6	626	US26D	26D	Satin Chromium Plated

RL Series Cylindrical Levers

RL Series lever designs

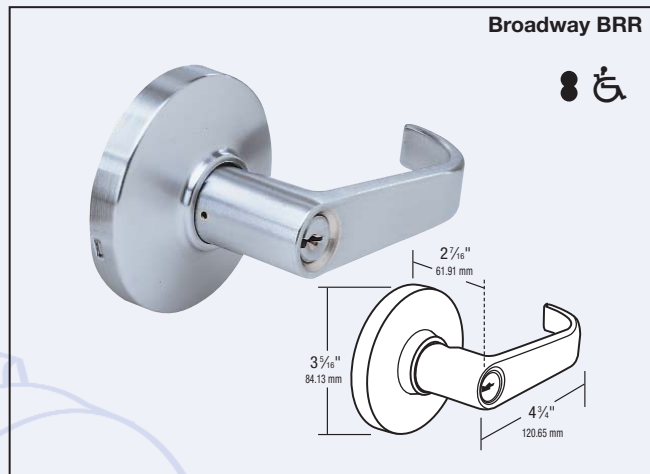
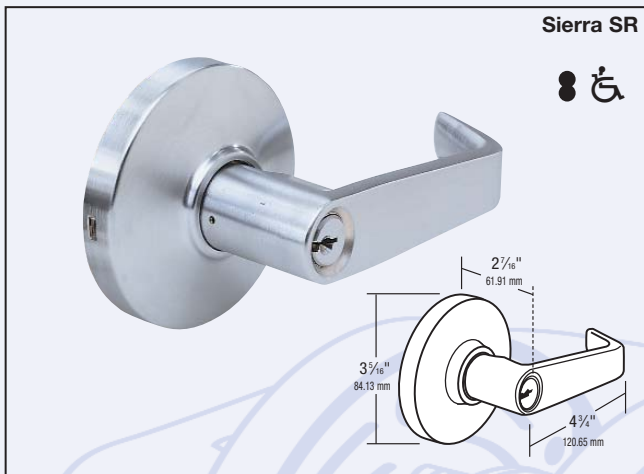

R Series cylinders

Solid Brass 6 pin cylinder pinned 5 for RK, pinned 6 for RL. "A" Keyway standard. Arrow sectional keyways available. Competitive keyways available. US4, US26D finish.

Tailpieces

Part #	Series
1001-44	RL Series
550AM-44	RK Series

Interchangeable Core

Look for this symbol to indicate availability of product with interchangeable core design.

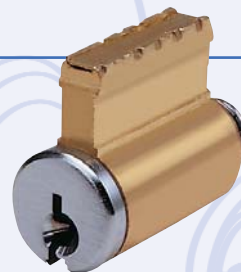

Cylinder Part

- #100C – RK Series
- #600HD – RL Series

RL Series Cylindrical Levers

ASSA ABLOY, the global leader in door opening solutions

Latches & Strikes:

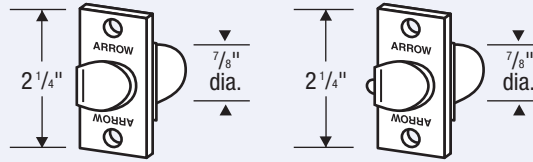

Latch Standards	UL Spring Latches	UL Dead Latches	Strikes
2-3/8" Backset	<p>#R72</p>	<p>#R70</p>	<p>#300 #302</p> <p>ANSI 115.3</p>
2-3/4" Backset	<p>#R73</p>	<p>#R71</p>	<p>#303 #306</p> <p>ASA ANSI 115.2</p>

Accessories:

Strikes	R62 Strike	R60 Strike	R61 Strike
	<p>ASA ANSI 115.2</p>	<p>Standard with RL Series</p> <p>ANSI 115.3</p>	<p>Standard with RK Series</p>

Installation:

161 prep for retrofit and secure installation.

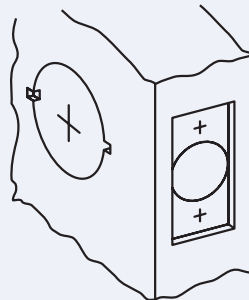





RL Series Cylindrical Levers

ASSA ABLOY, the global leader in door opening solutions

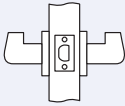
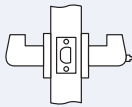
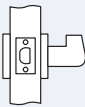

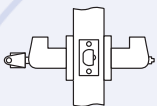
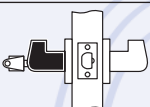
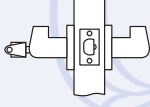
ASSA ABLOY

Arrow Standard	Function		Description
RL01	Passage		Latchbolt operated by lever either side.
RL02	Privacy		Latchbolt operated by lever either side except when inside turnbutton locks outside. Unlocked by rotating button or by using tool outside.
RL03	Communicating		Latchbolt by inside lever only. Blank rose only outside.
RL08	1/2 Dummy Trim		Rigid trim for one side of door only. Used as pull or to match active trim.
RL11	Entrance		Latchbolt operated by lever either side except when outside lever is locked by turn-button inside. When outside lever is locked, latchbolt operated by key outside or turning inside lever. Inside button must be manually released.
RL12	Storeroom		Outside lever always rigid. Latchbolt operated by key in outside lever, or by turning inside lever.
RL17	Classroom		Latchbolt operated by lever either side except when key outside locks outside lever. Inside lever always free. Key outside locks/unlocks outside lever only.
			Indicates lever rigid at all times.

How To Order:

Example: To order a RK Series entry function lockset with a Ball design lever, satin stainless steel finish, with a R60 strike, and 2-3/4" deadlocking latch, keyed different:

Specify:

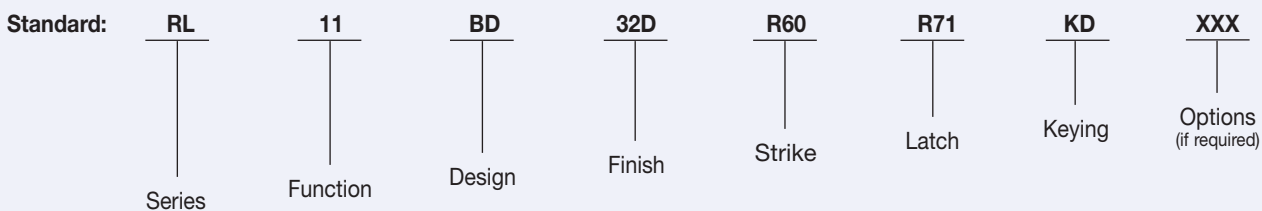

RL Series Cylindrical Levers

ASSA ABLOY, the global leader in door opening solutions



The return of the Comet brings with it the exceptional value and quality required to meet the demands of the single and multi-family housing markets, as well as light commercial applications.

Combining a variety of knob and lever designs, convenient installation and the Arrow benchmark for dependability, the C Series is perfect in most any space.

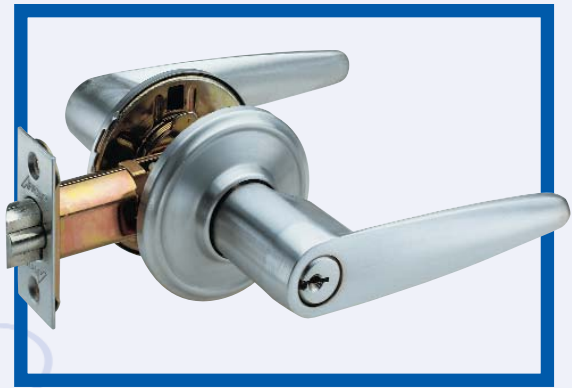

Certification

The C Series has been designed to meet the requirements of ANSI, A156.2, Series 4000, Grade 2.

ADA/Americans with Disabilities Act

Acceptable Door Hardware: Section 4.13.9

Handles, pulls, latches and other operating devices on accessible doors shall have a shape that is easy to grasp with one hand and does not require grasping, tight pinching or twisting of the wrist to operate. Lever operated mechanisms, push-type mechanisms and “U” shaped handles are acceptable designs.

 Look for the universal symbol next to Arrow products that comply with ADA accessibility requirements.

Features

Construction—Tubular chassis

Backset—Universal latch is standard. Adjustable for both 2-3/8" (60mm) or 2-3/4" (70mm).

Latch—Brass front. Supplied standard with 1" x 2-1/4" (25mm x 57mm) square corner, 1" x 2-1/4" radius corner and 1-1/8" x 2-1/4" (29mm x 57mm) square corner latch fronts. Available with drive-in latches.

Strike—1-5/8" x 2-1/4" (41mm x 57mm) full lip strike standard. Available with 1-1/8" x 2-3/4" (29mm x 70mm) "T" strike, or 1-1/4" x 4-7/8" (32mm x 124mm) ANSI strike.

Door Thickness—Fits 1-3/8" to 1-3/4" (35mm-44mm) doors standard.

Exposed Trim—Knobs are wrought brass. Levers are zinc based and are plated to match finish requirements.

Mounting—Knobsets are supplied with exposed screws on inside rose. Leversets are supplied with concealed screws on inside rose.

Cylinder—Solid brass, 6 pin tumbler, pinned 5. "A" keyway standard. Available in a variety of competitive manufacturers keyways. Supplied with 2 brass keys.

Finishes—US3, US5, US26, US26D, US15

Packaging—Both knob and leversets are packed 1 per box, 20 per carton.

Warranty—5 year mechanical, 5 year finish.

Finishes



	BMHA	U.S. Equiv	Arrow Equiv	Finish
1	605	US3	03	Bright Brass
2	606	US4	04	Satin Brass
3	609	US5	05A	Satin Brass, Blackened
4	625	US26	26	Bright Chromium Plated
5	626	US26D	26D	Satin Chromium Plated
6	619	US15	15	Nickel Plated

C Series Residential Lock

CL Series lever designs

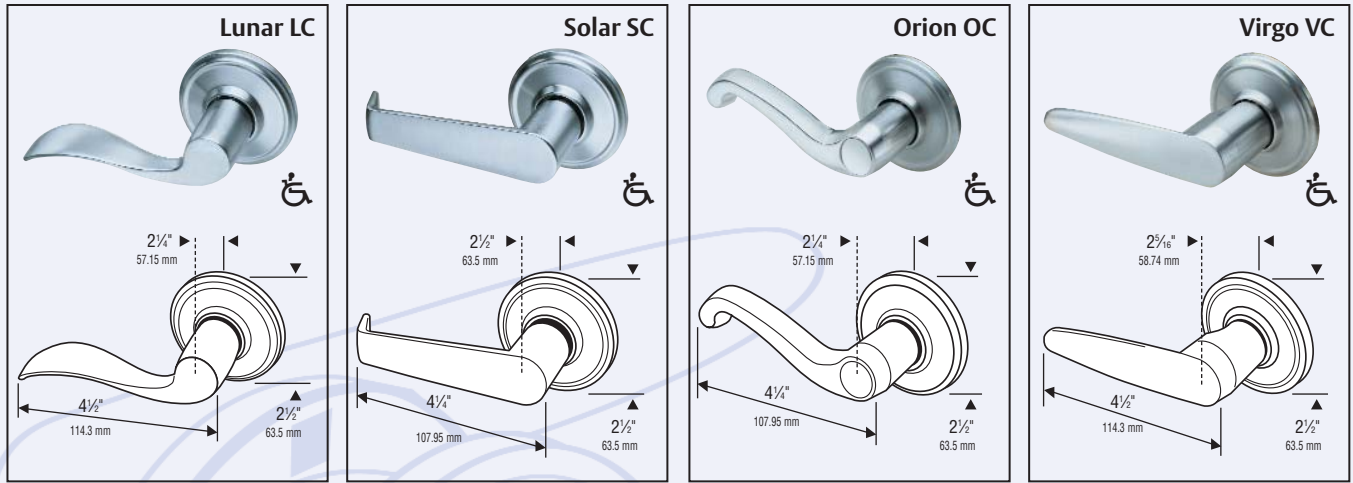

CK Series knob designs

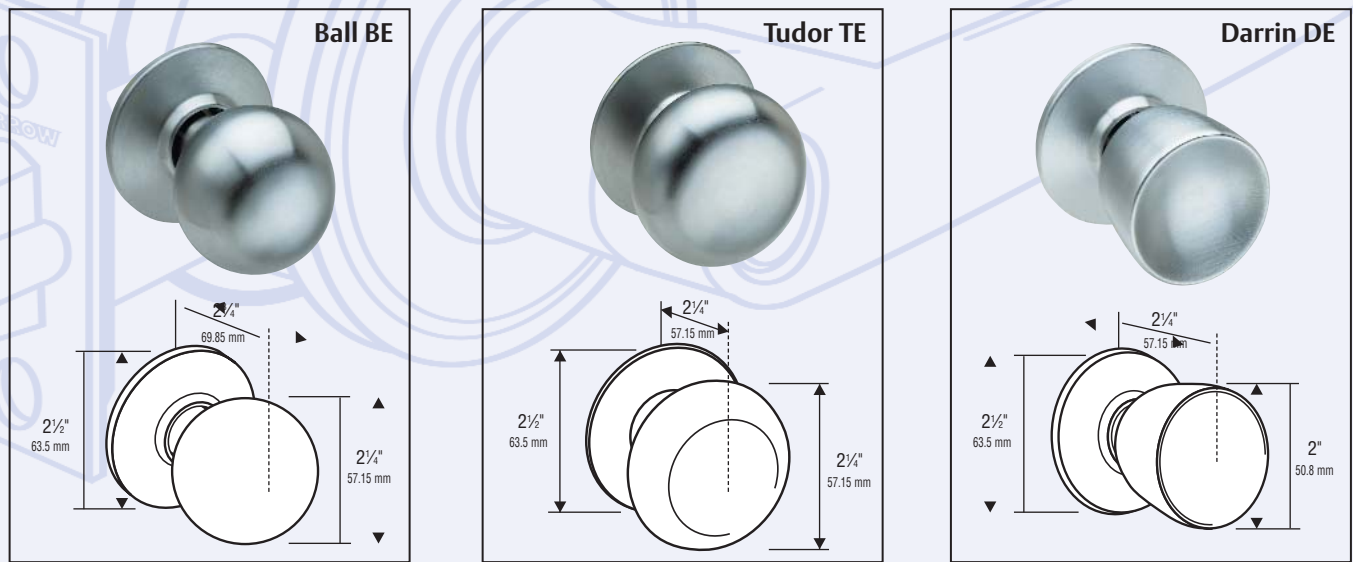

C Series cylinders

Solid brass pin tumbler 6 chambers. Pinned 5 for Grade 2 Locksets. "A" keyway standard. Arrow sectional keyways available. Competitive keyways available. US4, US26D finish.

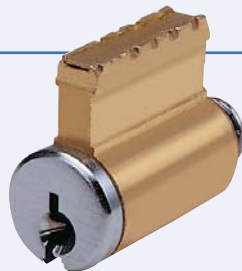

Tailpieces

Part #	Description
10CL-44	Standard Tailpiece (except for BE design)
10CB-44	Standard Tailpiece for BE design

Cylinders

Part #	Description
100YC	Standard Cylinder with tailpiece (except for BE design)
100YC-750	Standard Cylinder with tailpiece for BE design

C Series Residential Lock

Latches & Strikes:

Latches

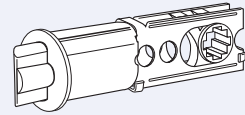
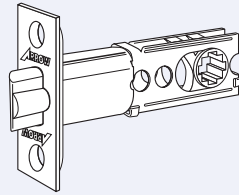
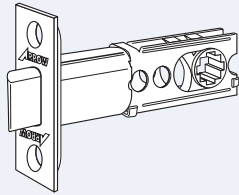

Spring Latch

Dead Latch

Drive-In

2-3/8" - 2-3/4"
Adjustable Backset

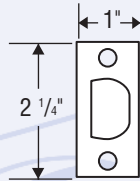

#501 Standard
Optional UL Latch #531

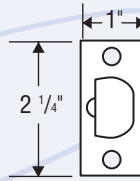

#511 Standard
Optional UL Latch #521



Spring Latch
#505

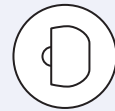

Dead Latch
#515

Note: Standard latch provided with these three faceplates.

- 1" x 2-1/4" square corner
- 1" x 2-1/4" radius corner
- 1-1/8" x 2-1/4" square corner

Note: Standard latch provided with these three faceplates.

- 1" x 2-1/4" square corner
- 1" x 2-1/4" radius corner
- 1-1/8" x 2-1/4" square corner

Accessories:

Strikes

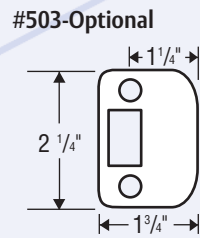
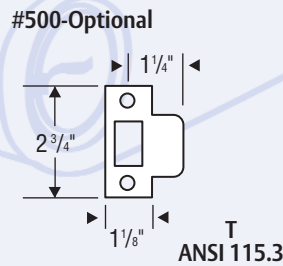
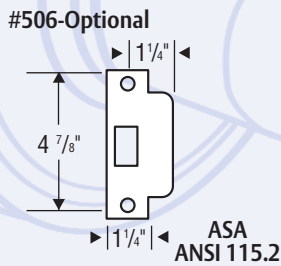
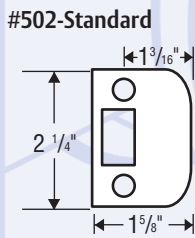

Installation:

Standard 2-1/8" door prep.

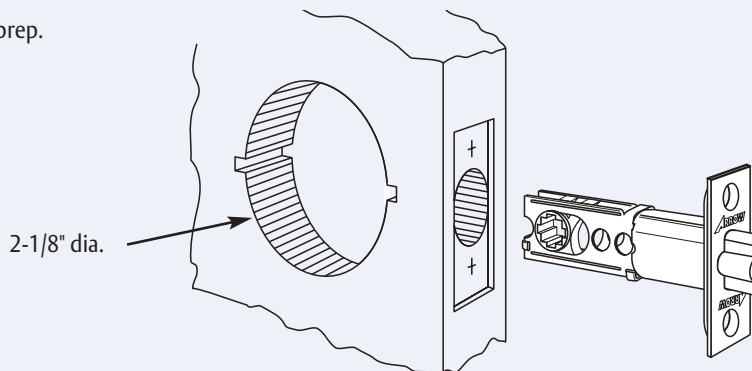

C Series Residential Lock

ASSA ABLOY, the global leader in door opening solutions



ASSA ABLOY

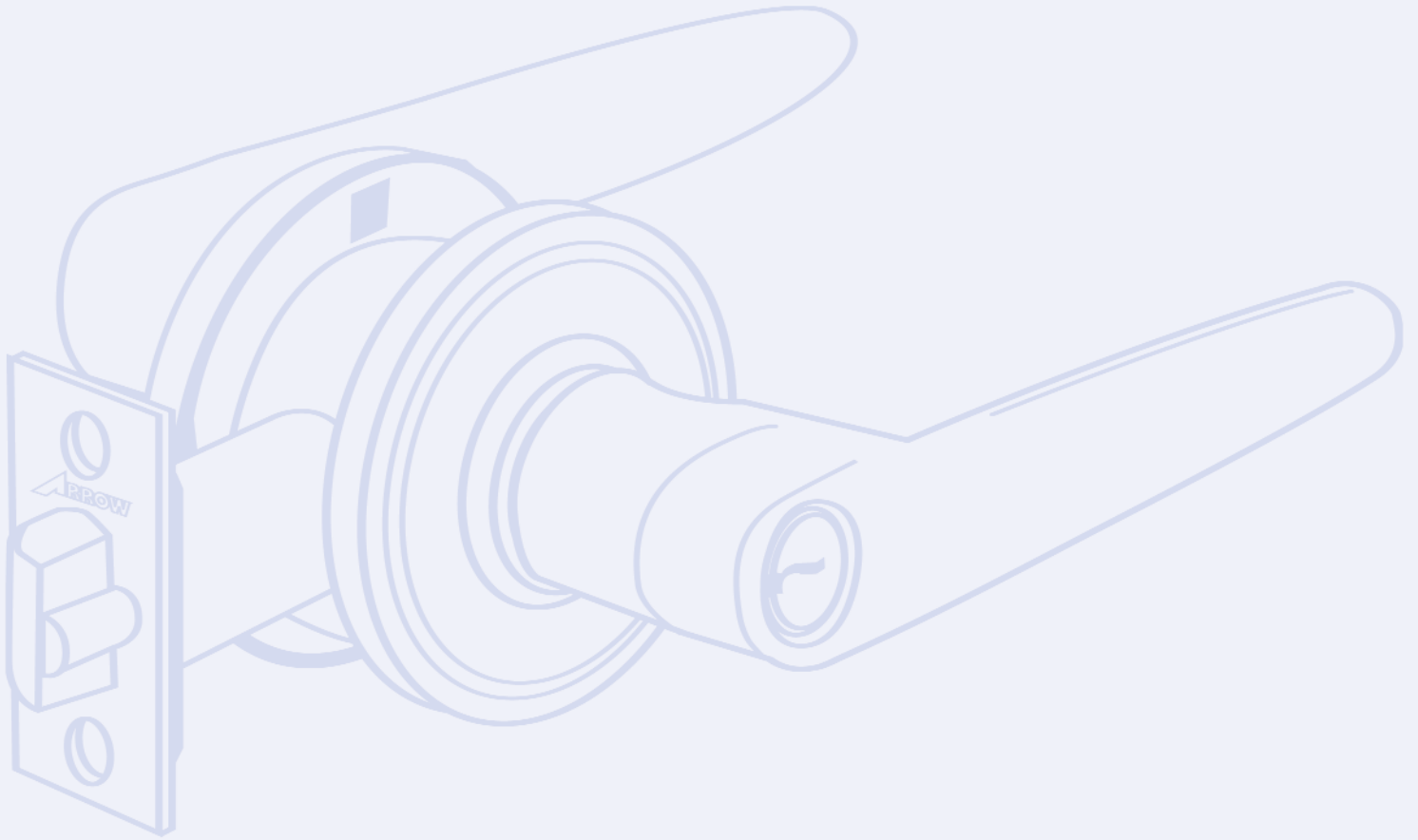

C Series Residential Lock

ASSA ABLOY, the global leader
in door opening solutions



ASSA ABLOY



LIGHT PRODUCTS												
SFIC	MORTISE LOCKS	CYLINDRICAL LEVERS	TUBULAR LOCKS	CYLINDRICAL KNOBS	DEADBOLTS	DOOR CLOSERS	INTER-CONNECTED LOCKS	ALARMED HARDWARE	ELECTRONIC DEVICES			
PREMIER Palatka Plus Premier Plus Design Lockable Reversible Solid Brass Cylindrical Reversible Recessed Design	AA/BA GRADE 1 28 Functions 13 lever designs 31 lever designs A Inset Recessed	Q W ML L RL C GRADE 2 17 Functions (D) 18 Functions (M) 3 lever designs 2 lever designs IC core system IC core system	H S MK RK GRADE 2 20 Functions (M) 18 Functions (D) 4 lever designs 3 lever designs 2 lever designs (D) 2 lever designs (M) IC core system	D E GRADE 2 7 Functions 7 Functions IC core system	900N 9016N GRADE 2 Standard for 7'6" open D Inset	JL GRADE 1 3 Styles 4 Hardware Finishes 2 finishes 5000 (100) Palatka (300) Palatka (400)	100 300 400 500 1000 3000 4000	500 1000 3000 4000	500 1000 3000 4000	500 1000 3000 4000	500 1000 3000 4000	
CLASSIC Palatka Solid Brass Reversible Reversible Recessed Recessed Design	AA/BA GRADE 2 28 Functions 13 lever designs 31 lever designs A Inset Recessed	Q W ML L RL C GRADE 2 17 Functions (M) 7 Functions (L) 3 lever designs (M) 2 lever designs (L) 0 finishes Quadrant Option (M) IC core system (M)	H S MK RK GRADE 2 17 Functions 6 designs 7 finishes IC core option	D E GRADE 2 8 styles (4 LG&L) 6 Functions (S) 3 Function (R) 7 finishes IC core option (S)	900N 9016N GRADE 2 Standard for 7'6" open D Inset	JL GRADE 2 4 Functions 3 lever designs 7 finishes IC core option	100 300 400 500 1000 3000 4000	500 1000 3000 4000	500 1000 3000 4000	500 1000 3000 4000	500 1000 3000 4000	
VALUE	AA/BA GRADE 2 7 Functions 2 lever designs 0 finishes IC core option	Q W ML L RL C GRADE 2 7 Functions 4 lever designs 3 lever designs 2 finishes IC core option	H S MK RK GRADE 2 8 Functions 3 designs 0 finishes IC core option	D E GRADE 2 8 Functions 3 designs 0 finishes IC core option	900N 9016N GRADE 2 Standard for 7'6" open D Inset	JL GRADE 1 2 styles: rim & SVR 2 finishes	100 300 400 500 1000 3000 4000 5000	500 1000 3000 4000	500 1000 3000 4000	500 1000 3000 4000	500 1000 3000 4000	



Cylindrical Knob Locksets

H, S, MK, RK Series

ASSA ABLOY, the global leader in door opening solutions



H Series cylindrical lock



General Specifications

Lock Chassis – Cold rolled steel with zinc dichromate finish for corrosion resistance. Latch retractor is precision cast steel. Requires standard 2-1/8" (53.97mm) bore through door.

Backset – 2-3/4" (69.85mm) backset standard, 3-3/4" (95.25mm) and 5" (127mm) available.

Door Thickness – 1-3/4" (44.45mm) to 2" (50.80mm)

Latch – Brass with 1/2" (12.7mm) throw. 3/4" (19.05mm) throw deadlocking firelatch available for pairs of doors. Latch housing is steel, zinc dichromate finish for corrosion resistance. 1" (25.4mm) bore in edge of door required.

Latch Front – Brass, bronze or stainless steel, 2-1/4" (57.15mm) x 1-1/8" (28.57mm), beveled 1/8" (3.17mm) in 2" (50.8mm)

Strike – Brass, bronze or stainless steel. ANSI A115.2, 4-7/8" (123.82mm) x 1-1/4" (31.75mm) curved lip standard. Optional 2-3/4" (69.85mm) x 1-1/8" (28.57mm) available.

All strikes have 1-1/4" (31.75mm) lip to center dimension. Box strike available.

Handing – Reversible.

Cylinder, Standard – Solid brass, 6 pin cylinder with Arrow "A" keyway. Can be masterkeyed, grandmaster keyed and construction masterkeyed. Conventional cylinders also available in a variety of competitive manufacturer's keyways. Supplied with two 6 pin nickel silver keys.

Cylinder Options – Interchangeable core-lockset prepared for use with 6 or 7 pin interchangeable core. Supplied less core, but packed with 6 and 7 pin tailpieces. Will accept Best™ and Falcon™ type cores. Suffix "IC" to design.

S Series cylindrical lock

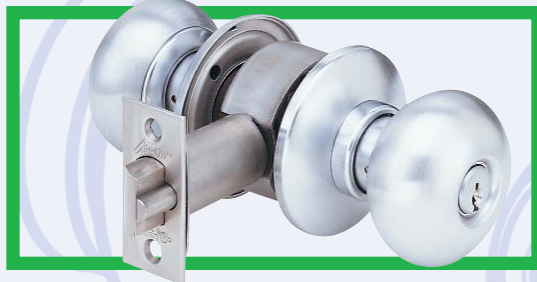

General Specifications

Lock Chassis – Stainless steel construction for corrosion resistance. Requires standard 2-1/8" (53.97mm) bore through door.

Backset – 2-3/4" (69.85mm)

Door Thickness – 1-3/8" (34.925mm) to 2" (50.80mm).

Latch – Brass with 1/2" (12.7mm) throw. Latch housing is stainless steel and requires a 1" (25.40mm) bore in the edge of the door.

Latch Front – Stainless steel, 2-1/4" (57.15mm) x 1-1/8" (28.57mm), or 2-1/4" (57.15mm) x 1-1/8" (28.57mm) full radius. Available with either flat or beveled fronts.

Strike – Stainless steel. Standard marine strike measures 2-3/4" (69.85mm) x 1-1/8" (28.57mm) and has full radius with 7/8" (22.225mm) lip to center dimension. Available with ANSI A115.2 strike measuring 4-7/8" (123.95mm) x 1-1/4" (31.75mm) lip to center dimension.

Handing – Reversible.

Cylinder, Standard – Solid brass, 6 pin cylinder with standard Arrow "A" keyway. Can be masterkeyed, grandmaster keyed and construction masterkeyed. Supplied with two 6 pin nickel silver keys.

Cylinder Options – Interchangeable core-lockset prepared for 6 or 7 pin interchangeable cores. Supplied less core, but packed with 6 and 7 pin tailpieces. Will accept cores as manufactured by Best™, Falcon™ and other similar style cores. Suffix "IC" to design

All non-ferrous material for marine use.

H&S Series Cylindrical Lock

H Series cylindrical lock

Arrow Grade 1 Cylindrical Locksets are engineered and designed for lasting performance. They represent an outstanding value in builders' hardware.

H Series Knob Designs

Matching trim available to complement other series of cylindrical locks, AM Series Mortise locks, exit devices and alarms.

Finish

US3, US4, US10, US10B, US26, US26D, US32, US32D

Certification & Compliance

- ANSI/BHMA A156.2, Series 4000, Grade 1
- Underwriters Laboratories (UL and CUL) listed for use on 3 hour, A label single swinging doors
- Federal Specification FF-H-106C

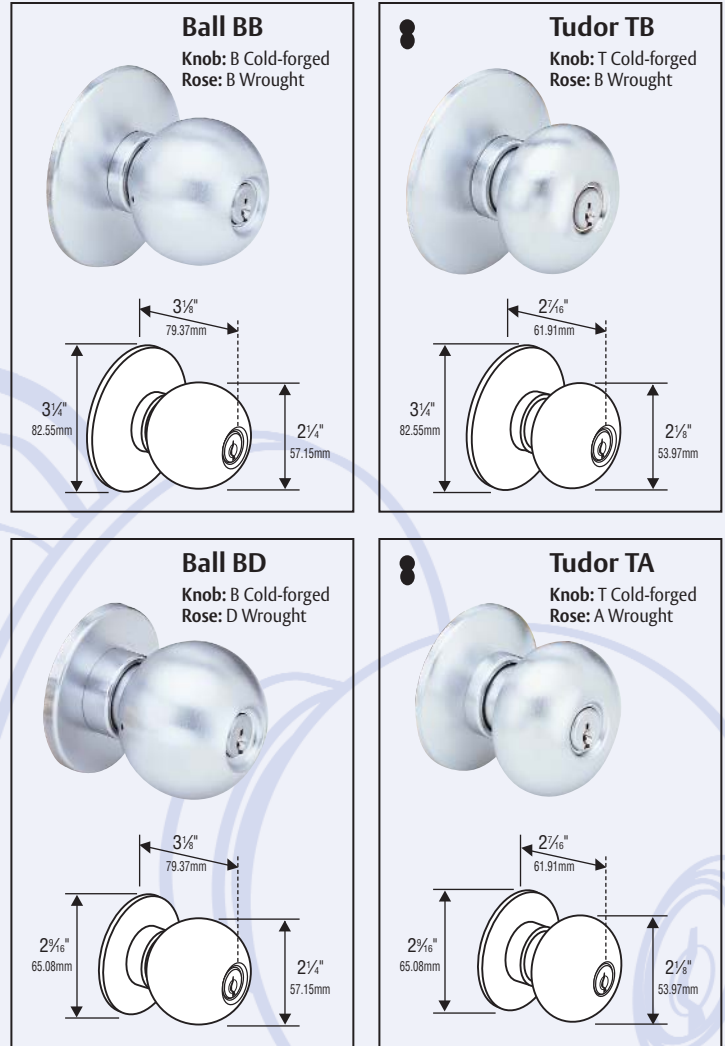

H&S Series Cylindrical Lock

S Series cylindrical lock

The S Series is constructed of stainless steel and corrosion resistant components specifically for marine applications.

S Series Knob Designs (Marine Series)

Matching trim available to complement other series of cylindrical locks, AM Series mortise locks, exit devices and alarms.

Finish

US32, US32D

Certification & Compliance

- ANSI/BHMA A156.2, Series 4000, Grade 1
- Underwriters Laboratories (UL and CUL) listed for use on 3 hour, A label single swinging doors.
- Federal Specifications FF-H-106C, Series 161.

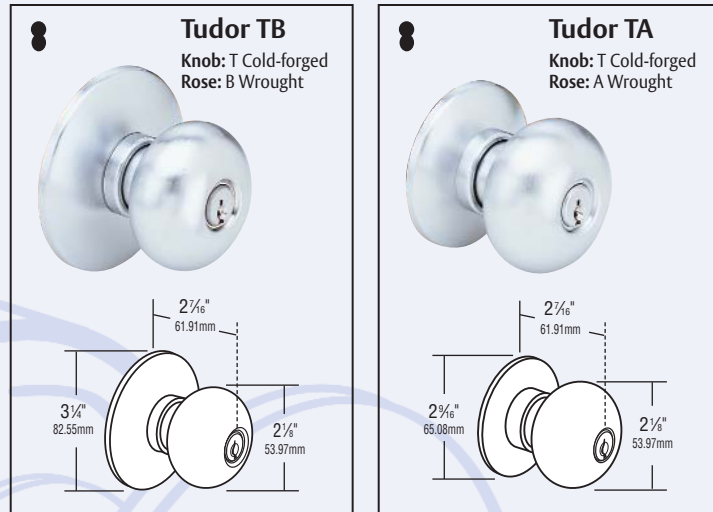

H&S Series Cylindrical Lock

ASSA ABLOY, the global leader
in door opening solutions



ASSA ABLOY

H & S Series cylindrical lock

Cylinders

Conventional – H & S Series locksets are supplied standard with Arrow “A” keyway, 6 pin cylinder. As with all other lock series, various levels of masterkeying are available. Conventional cylinders are available in a variety of competitive manufacturers keyways. Supplied with two nickel silver keys.

- Cylinder Options** – Interchangeable core – lockset prepared for use with 6 or 7 pin interchangeable core. Supplied less core, but packed with 6 and 7 pin tailpieces. Will accept cores manufactured by Best™, Falcon™, Medeco Keymark™ and others. Suffix “IC” to design. Temporary Arrow construction cores are also available.

Interchangeable Core

- Look for this symbol to indicate availability of product with interchangeable core.

Finishes*







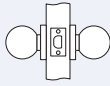
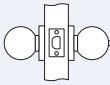

	BHMA	U.S. Equivalent	Arrow Equivalent	Finish
1	605	US3	03	Bright Brass
2	606	US4	04	Satin Brass
3	612	US10	10	Satin Bronze
4	613	US10B	10B	Dark Oxide Bronze, Oil Rubbed
5	625	US26	26	Bright Chromium Plated
6	626	US26D	26D	Satin Chromium Plated
7	629	US32	32	Bright Stainless Steel
8	630	US32D	32D	Satin Stainless Steel

*S Series US32 & US32D only.

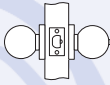
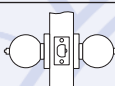
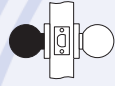
H&S Series Cylindrical Lock

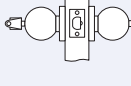
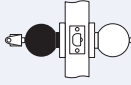
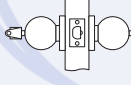
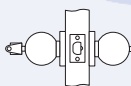
Knob Functions H & S Series Grade 1

Arrow Standard	Series	ANSI/FED#	Function		Description
01	H, S	F75/161N, 160N	Passage/Closet		Latchbolt operated by knob/lever either side.
02	H, S	F76/161L, 160L	Privacy/Bathroom		Latchbolt operated by knob/lever either side except when inside pushbutton locks outside knob. Unlocked by turning inside knob, using emergency key outside or closing door.
03	H		Communicating		Latchbolt by inside knob/lever only. Blank rose only outside.
04	H, S	F77/161P, 160P	Terrace		Deadlocking latchbolt operated from either side, except when inside pushbutton locks outside knob. Unlocked by turning knob or closing door. Not recommended for doors in rooms with no other entrance.
05	H	F78/161M, 160M	Communicating		Deadlocking latchbolt operated by knob either side except when turnbutton in either knob locks knob on opposite side.
07	H, S	F89/161NX	Exit		Deadlocking latchbolt operated by inside knob only. Outside knob always rigid.
08	H		Single Dummy Trim		Rigid trim for one side of door only. Used as pull or to match active trim.
11	H, S	F109 (F81 & F82)/ 161A, 160A	Entrance/Office		Latchbolt operated by knob either side except when outside knob is locked by turnbutton inside. When outside knob is locked, latchbolt operated by key outside or turning inside knob. Pushing and turning inside button will cause outside knob to remain locked. Button will then need to be manually rotated to unlock outside knob.
12	H, S	F86/161D, 160D	Storeroom		Latchbolt operated by key in outside knob or by inside knob. Outside knob always rigid.
13	H, S	F82/161B, 160B	Exterior		Latchbolt operated by knob from either side except when outside knob is locked by pushbutton inside. Outside knob remains locked until unlocked by key or turning inside knob.
14	H	F92/161E, 160BE	Service Station		Latchbolt operated by knob either side except when slotted pushbutton inside locks outside knob. Outside knob unlocked by turning inside knob or closing door. When slotted button is pushed and turned, outside knob is rigid and is unlocked either by key outside or by turning inside knob. Inside knob always free.
					Indicates knob rigid at all times.

H&S Series Cylindrical Lock

Knob Functions H & S Series Grade 1

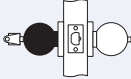
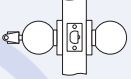
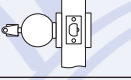
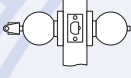
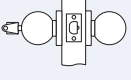
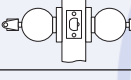
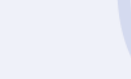
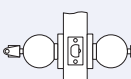
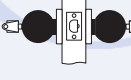
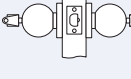
Arrow Standard	Series	ANSI/FED#	Function	Description
15	H	F793/161H, 160H	Hotel/Motel	 <p>Latchbolt operated by inside knob at all times. Outside knob rigid at all times. Key outside will retract latchbolt except when pushing inside button shuts out all keys except emergency key and activates visual occupancy indicator on face of cylinder. Turning inside knob or closing door releases button and retracts visual indicator. Turning inside button with spanner key will lock button in fixed position. Button then released with spanner or emergency key.</p>
17	H, S	F84/161LR, 160R	Classroom	 <p>Latchbolt operated by knob either side except when key outside locks outside knob. Inside knob always free. Key outside locks/unlocks outside knob only.</p>
18	H		Communicating	 <p>Deadlocking latchbolt by knob inside only except when key locks/unlocks knob. Blank rose only outside.</p>
19	H, S	F90/161T	Dormitory	 <p>Latchbolt operated by knob either side except when outside knob is locked by key outside or pushbutton inside. Key outside locks or unlocks outside knob. Unlocked by turning inside knob, closing door or using key outside.</p>
20	H	F85	Classroom	 <p>Latchbolt operated by knob from either side except when key outside locks outside knob. Inside knob always free. Key outside locks/unlocks outside knob only. Latchbolt can be held in a retracted position by outside key.</p>
31	H, S	F80/161S, 160S	Communicating	 <p>Latchbolt operated by knob either side. Key in either knob locks its own knob independently. Not recommended for use in rooms with no other entrance.</p>
32	H, S	F88/161C, 160C	Public Entrance	 <p>Latchbolt operated by knob from either side except when key from inside knob locks outside knob. When outside knob is locked, latchbolt retracted by key in outside knob or by turning inside knob.</p>
33	H, S	F87/161W, 160W	Asylum/Institutional	 <p>Latchbolt operated by key in either knob. Both knobs always rigid.</p>
35	H, S	F91/161G	Exterior Doors	  <p>Latchbolt operated by knob from either side except when both knobs are locked by key from either side.</p>



Indicates knob rigid at all times.

H&S Series Cylindrical Lock

H & S Series cylindrical lock

Latches

Latches

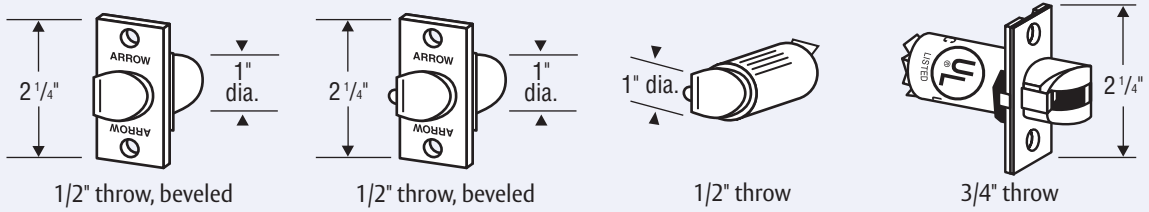

Spring Latch

Dead Latch

Drive-In

Fire Door

H Series 2-3/4" Backset	#160, U.L.	#161, U.L.	#164	#179, U.L.
S Series 2-3/4" Backset Stainless Steel	#162, U.L. #169	#163, U.L. #170	N/A	N/A

Strikes

Strikes

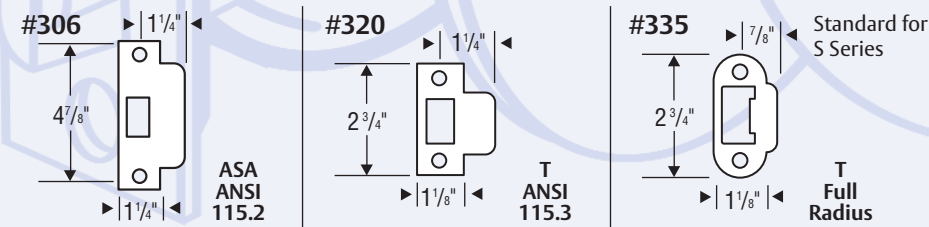

Boxes

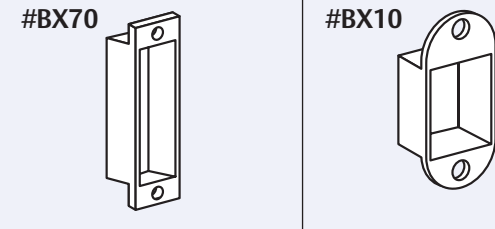

H&S Series Cylindrical Lock

H & S Series cylindrical lock

Suggested Specification

All locksets shall be H & S Series Cylindrical locksets as supplied by Arrow Lock company.

Locksets shall meet ANSI/BHMA requirements for Series 4000, Grade 1, and shall be U.L. and c.U.L. listed for 3 hour, A label openings.

Lockset shall be non-handed. Lockset shall have no exposed screws. Chassis mounting screws may be accessed only when knob and rose are removed.

Trim shall consist of wrought with wrought brass or bronze rose scalps.

Disassembly of lockset for cylinder removal shall not be required. Cylinder shall be changed by removing the knob.

All products shall be of one manufacturer and shall comply with Federal Acquisition Regulations (FAR) for products made in the U.S.A.

All locksets shall carry a one year limited warranty.

How To Specify

Example: To order a S Series entrance function lockset with a TA design, satin chrome finish, with an ASA strike and 2-3/4" backset, keyed different:

Specify:

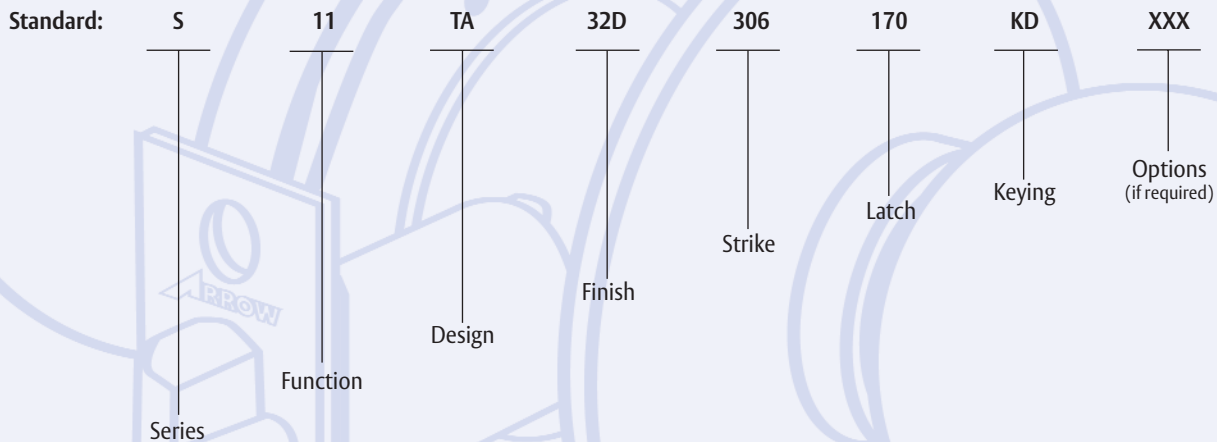

Installation

161 prep for retrofit and secure installation.

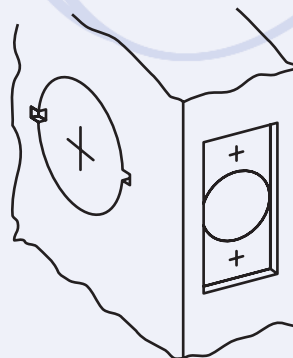

H&S Series Cylindrical Lock

Arrow MK Series offer the designer, architect and contractor simple solutions to accessibility requirements. Their clean designs, architectural finishes and available functions make them ideal for commercial applications where heavy duty grade one hardware may not be necessary.



Certification

All Arrow MK Series locks are U.L. and c.U.L. listed for use on 3 hour, A label or lesser doors and are certified to conform to the requirements of ANSI/BHMA A156.2, Series 4000, Grade 2.

- Federal Specification FF-H-106C

General Specifications

Lock Chassis – Cold rolled steel with zinc dichromate finish for corrosion resistance. Requires standard 2-1/8" (53.97mm) bore through door.

Backset – 2-3/8" (60.32mm) standard. 2-3/4" (69.85mm), 3-3/4" (95.25mm) and 5" (127mm) available.

Door Thickness – 1-3/8" (34.92mm) to 1-3/4" (44.45mm).

Latch – Brass with 1/2" (12.7mm) throw. Latch housing is steel, with zinc dichromate finish for corrosion resistance. 7/8" (22.225mm) bore in edge of door is required.

Latch Front – Brass or bronze. Standard faceplate for 2-3/8" (60.32mm) backset measures 2-1/4" (57.15mm) x 1" (25.40mm) with a flat front, for 2-3/4" (69.85mm) backset standard faceplate measures 2-1/4" (57.15mm) x 1-1/8" (28.57mm) with beveled front 1/8" (3.17mm) in 2" (50.8mm).

Strike – Brass, bronze or stainless steel. Standard "T" strike measures 2-3/4" (69.85mm) x 1-1/8" (28.57mm). Optional ANSI A115.1 strike measures 4-7/8" (123.82mm) x 1-1/4" (31.75mm).

All strikes have a 1-1/4" (31.75mm) lip to center dimension.

Handing – Reversible.

Cylinder, Standard – Solid brass 6 pin cylinder with Arrow "A" keyway, keyed to 5 pin for stock. Can be masterkeyed, grandmaster keyed and construction masterkeyed. Conventional cylinders are also available in a variety of competitive manufacturer's keyways. Supplied with two 5 pin brass keys for stock.

MK Series Cylindrical Locksets

Designs

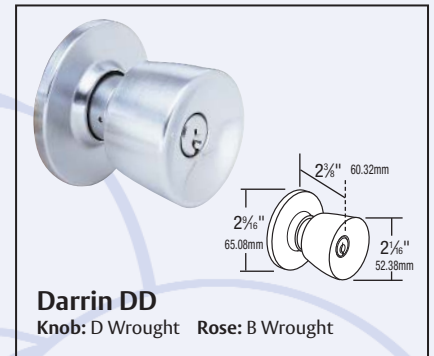
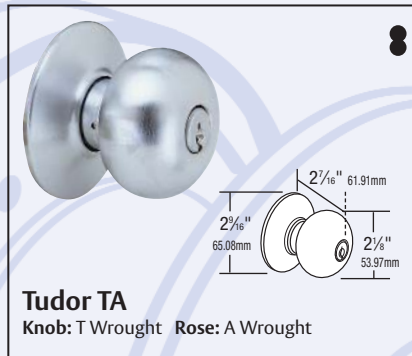
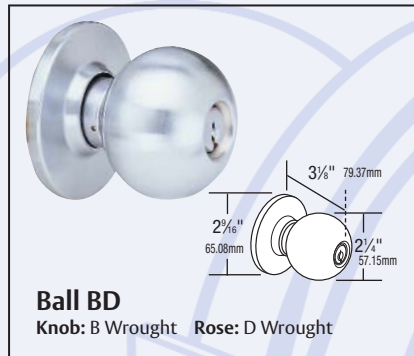
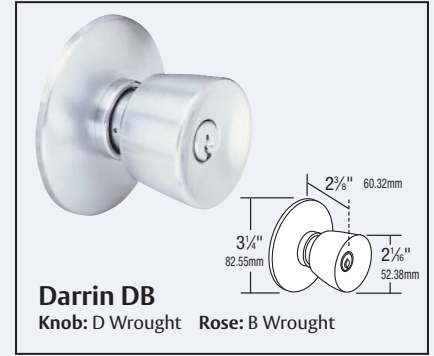
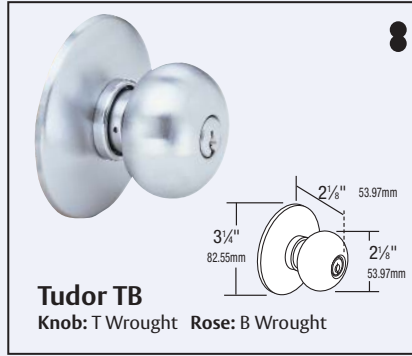
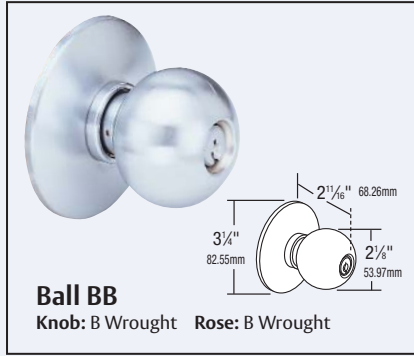

Finishes



	BHMA	U.S. Equivalent	Arrow Equivalent	Finish
1	605	US3	03	Bright Brass
2	606	US4	04	Satin Brass
3	609	US5	05A	Antique Brass
4	612	US10	10	Satin Bronze
5	613	US10B	10B	Dark Oxide Bronze, Oil Rubbed
6	619	US15	15	Nickel Plated
7	625	US26	26	Bright Chromium Plated
8	626	US26D	26D	Satin Chromium Plated

Cylinder Options





Conventional—MK Series locksets are supplied standard with Arrow “A” keyway, 6 pin cylinder. As with all other lock series, various levels of masterkeying are available. Conventional cylinders are available in a variety of competitive manufacturers keyways. Supplied with two brass keys.

Interchangeable Core—Lockset prepared for use with 6 or 7 pin interchangeable core. Supplied less core, but packed with 6 and 7 pin tailpieces. Will also accept cores manufactured by Best™, Falcon™, Medeco Keymark™ and others. Suffix “IC” to design. Temporary Arrow construction cores are also available.

Interchangeable Core

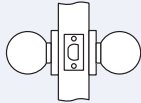
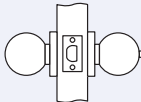
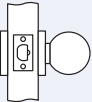
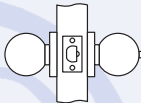
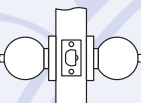
Look for this symbol to indicate availability of product with interchangeable core.

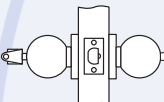
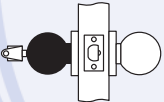
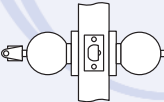
MK Series Cylindrical Locksets

Arrow Standard	ANSI/ FED#	Function		Description
MK01	F75/161N, 160N	Passage		Latch bolt operated by knob from either side at all times
MK02	F76/161L, 160L	Privacy		Latch bolt operated by knob from either side. Outside knob is locked by push button inside and unlocked by emergency release outside, operating inside knob or closing door.
MK03	F111	Communicating Passage		Dead locking latch bolt operated by knob one side only at all times. Non removable blank trim outside.
MK04	F77/161P, 160P	Patio		Dead locking latch bolt operated by knob from either side. Outside knob is locked by push button inside and unlocked by operating inside knob or closing door. Do not use on doors in rooms that have no other entrance.
MK05	F78/161M, 160M	Communicating		Dead locking latch bolt operated by knob from either side. Turn button on either side locks or unlocks opposite knob. Do not use on doors in rooms that have no other entrance.
MK08		Single Dummy Trim		Rigid trim for one side of door only. Used as pull or to match active trim.
MK11	F109 (F81 & F82)/ 161A, 160A	Entrance/Office		Dead locking latch bolt operated by knob from either side except when outside knob is locked by pushing turn button inside. Key outside or operating inside knob releases turn button unlocking outside knob except when turn button has been rotated to keep outside knob locked. Inside turn button must be manually operated to unlock outside knob. Inside knob always operates latch bolt.
MK12	F86/161D, 160D	Storeroom		Dead locking latch bolt operated by key in outside knob or by operating inside knob. Outside knob is always inoperable.
MK13	F82A/161B, 160B	Exterior		Dead locking latch bolt operated by knob from either side except when outside knob is locked by push button inside. When outside knob is locked, operating key in outside knob or operating inside knob unlocks push button and retracts latch bolt. Closing door does not release push button.
				Indicates knob rigid at all times.

MK Series Cylindrical Locksets

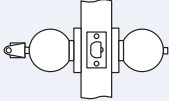
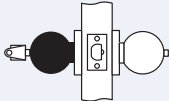
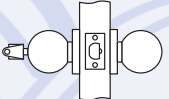
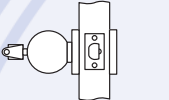
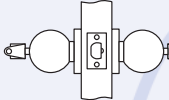
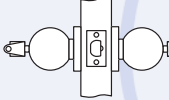
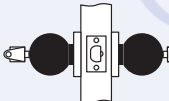
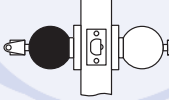
Arrow Standard	ANSI/FED#	Function		Description
MK14	F92/161E, 160E	Service Station		Dead locking latch bolt operated by knob from either side except when outside knob is locked by push button inside. Key outside, operating inside knob or closing door releases push button unlocking outside knob except when slotted push button is in a locked position. Inside knob always operates latch bolt.
MK15	F93/161H, 160H	Hotel		Dead locking latch bolt operated by knob from inside at all times. Outside knob always inoperable. Latch bolt operated by key from outside except when push button inside is operated thus shutting out all keys except emergency key. Operating push button operates outside visual indicator showing room is occupied. Operating inside knob or closing door releases indicator and shut out feature except when shut out is activated by turning inside button with spanner key.
MK17	F84/161R, 160R	Classroom		Dead locking latch bolt operated by knob from either side except when outside knob is locked from outside by key. When outside knob is locked, latch bolt is operated by inside knob.
MK18	F113	Communicating Classroom		Dead locking latch bolt operated by knob one side only except when knob is locked by key. Non removable blank trim outside.
MK31	F80/161S, 160S	Communicating		Dead locking latch bolt operated by knob from either side. Turning key in either knob locks or unlocks its own knob independently. Do not use on doors in rooms that have no other entrance.
MK32	F88/161C, 160C	Public Entrance		Dead locking latch bolt operated by knob from either side except when outside knob is locked by key from inside. When outside knob is locked, latch bolt is retracted by key in outside knob or by operating inside knob.
MK33	F87/161W, 160W	Asylum		Dead locking latch bolt operated by key in knob from either side. Both knobs always inoperable.
MK34		Exterior		Dead locking latch bolt operated by key from outside or by knob from inside except when inside knob is locked by key from inside knob. Outside knob is always inoperable.

MK Series Cylindrical Locksets

Latches & Strikes

Latches

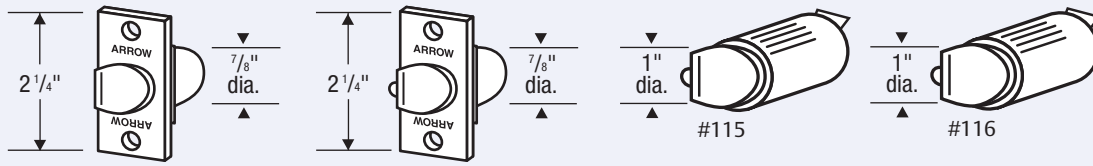

Latch Standards	Spring Latches	Dead Latches	Strikes
2-3/8" Backset	<p>#101 non-UL #221 UL</p>	<p>#111 non-UL #121 UL</p>	<p>#300 #302 ANSI 115.3</p>
2-3/4" Backset	<p>#104 non-UL #224 UL</p>	<p>#114 non-UL #124 UL</p>	<p>#303 #306 ASA ANSI 115.2</p>
3-3/4" Backset	<p>#108 non-UL #228 UL</p>	<p>#118 non-UL #128 UL</p>	<p>Boxes #BX70 #BX10 For 306 For 300</p>

Latch Options: #272 - 2-3/4" backset 1" x 2-1/4" #282 - 2-3/4" backset 1" x 2-1/4"

Accessories

Sleeve

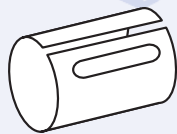

K-179: For 1" diameter latch hole, fits all spring and dead latches.

Extension Link

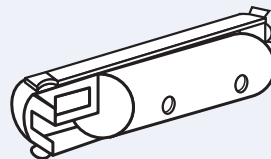

L25: For 5" backset. Used with 2-3/8" latches.

MK Series Cylindrical Locksets

Suggested Specification

All locksets shall be MK Series Cylindrical locksets as supplied by Arrow Lock company.

Locksets shall meet ANSI/BHMA requirements for Series 4000, Grade 2, and shall be U.L. and c.U.L. listed for 3 hour, A label openings.

Lockset shall be non-handed. Lockset shall have no exposed screws. Chassis mounting screws may be accessed only when knob and rose are removed.

Trim shall consist of wrought with wrought brass or bronze rose scalps.

Disassembly of lockset for cylinder removal shall not be required. Cylinder shall be changed by removing the knob.

All products shall be of one manufacturer.

All locksets shall carry a three year limited warranty.

How To Specify

Example: To order a MK Series classroom function lockset with a BB design, satin chrome finish, with an ASA strike and 2-3/4" backset, keyed different:

Specify:

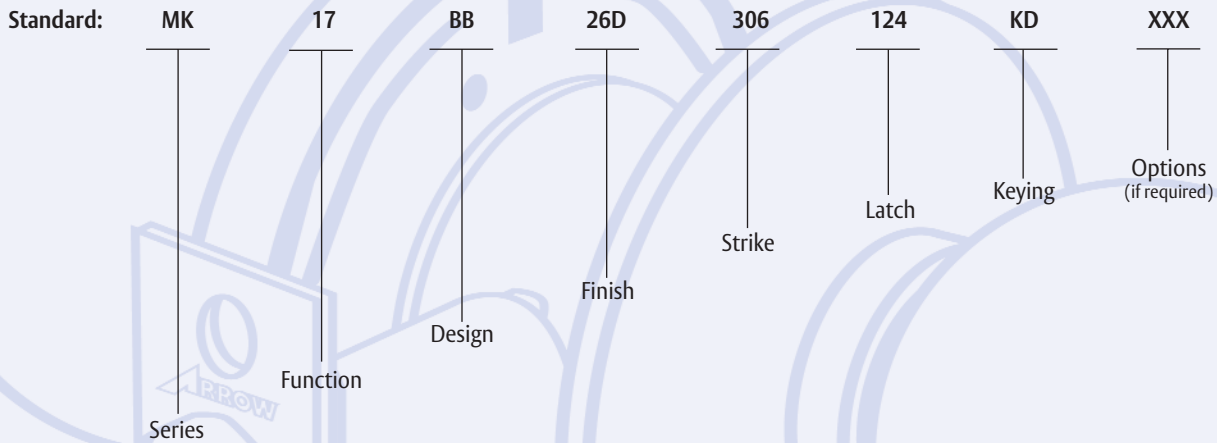

Installation

161 prep for retrofit and secure installation.

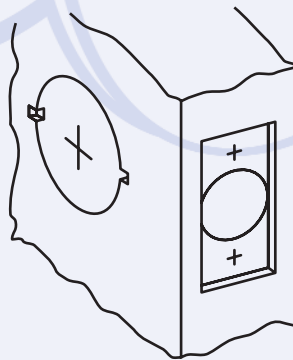

MK Series Cylindrical Locksets

ASSA ABLOY, the global leader in door opening solutions



ASSA ABLOY

The RK Series has been enhanced to offer a wide variety of finishes and functions. The RK Series cylindrical locksets are an economical value for a variety of application. Perfect for multi-family housing markets, as well as light commercial applications.

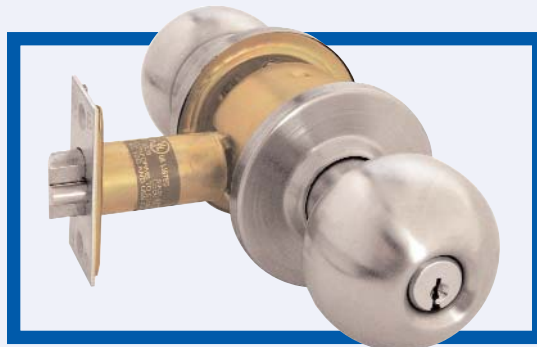

Certification

The RK Series has been designed to meet the requirements of ANSI, A156.2, Series 4000, Grade 2 UL Listed for use on 3 hour, A label single swinging doors.

Features

Construction – Cold rolled steel with zinc dichromate finish for corrosion resistance. Requires standard 2-1/8" (53.97mm) bore through door.

Backset – 2-3/8" (60.31mm) or 2-3/4" (69.85mm)

Door Thickness – Fits 1-3/8" (34.93mm) to 1-3/4" (44.45mm) doors standard.

Latch – Brass 1/2" (12.7mm) throw, UL Listed, guarded latchbolt on all locking functions

Latch Front – 1" x 2-1/4" (25.40mm x 57.15mm) for 2-3/8" backset (60.32mm) or 1-1/8" x 2-1/4" for 2-3/4" (69.85mm) backset.

Exposed Trim – RK Roses are wrought brass 2-1/2" (63.5mm) diameter. Total projection from face of door is 2-3/4" (69.85mm).

Strike – 4-7/8" ANSI (123.83mm), 2-3/4" (69.85mm) T strike, or 2-1/4" (57.15mm) full lip strike.

Cylinder – Solid brass 6 pin. Arrow "A" keyway standard. C keyway optional.

Keys – 2 brass keys

Handing – Non-handed

Thru-bolts – Removable thru-bolts standard on RL Series

Packaging – 10 per case

Warranty – Five Year Mechanical Warranty

Finishes:

RK is available in 03, 04, 10, 10B, 32 and 32D.

RL is available in 03, 04, 10, 10B, 26 and 26D.



	BHMA	U.S. Equivalent	Arrow Equivalent	Finish
1	605	US3	03	Bright Brass
2	606	US4	04	Satin Brass
3	612	US10	10	Satin Bronze
4	613	US10B	10B	Dark Oxide Bronze, Oil Rubbed
5	629	US32	32	Bright Stainless Steel
6	630	US32D	32D	Satin Stainless Steel

RK Series Cylindrical Locksets

RK Series knob designs

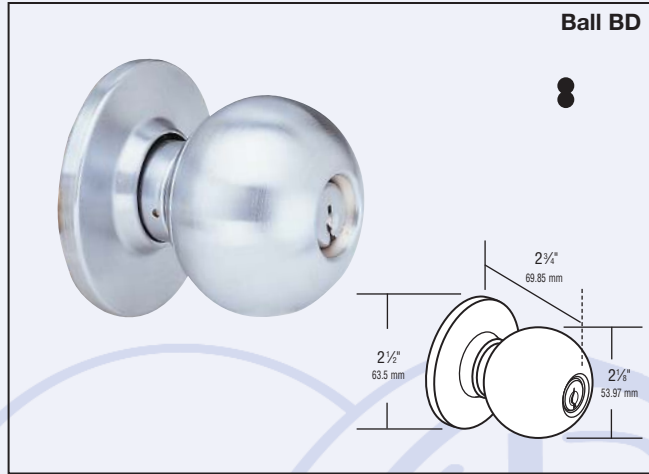

R Series cylinders

Solid Brass 6 pin cylinder pinned 5 for RK, pinned 6 for RL. "A" Keyway standard. Arrow sectional keyways available. Competitive keyways available. US4, US26D finish.

Tailpieces

Part #	Series
1001-44	RL Series
550AM-44	RK Series

Interchangeable Core

Look for this symbol to indicate availability of product with interchangeable core design.

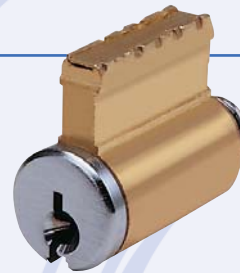

Cylinder Part
 #100C – RK Series
 #600HD – RL Series

RK Series Cylindrical Locksets

Latches & Strikes:

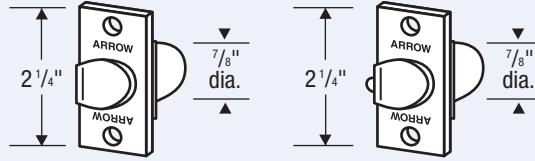

Latch Standards	UL Spring Latches	UL Dead Latches	Strikes
2-3/8" Backset	<p>#R72</p>	<p>#R70</p>	<p>#300 #302</p> <p>ANSI 115.3</p>
2-3/4" Backset	<p>#R73</p>	<p>#R71</p>	<p>#303 #306</p> <p>ASA ANSI 115.2</p>





Accessories:

Strikes	R62 Strike	R60 Strike	R61 Strike
	<p>Standard with RL Series</p> <p>ASA ANSI 115.2</p>	<p>Standard with RK Series</p> <p>ANSI 115.3</p>	

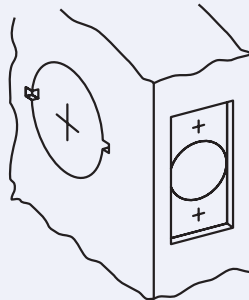
Installation:

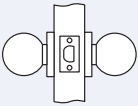
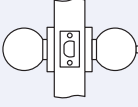
161 prep for retrofit and secure installation.

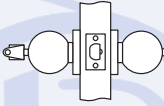
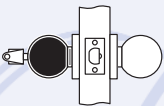
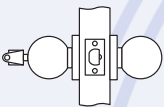

Arrow Standard	Function		Description
RK01	Passage		Latchbolt operated by knob/lever either side.
RK02	Privacy		Latchbolt operated by knob/lever either side except when inside turnbutton locks outside. Unlocked by rotating button or by using tool outside.
RK08	1/2 Dummy Trim		Rigid trim for one side of door only. Used as pull or to match active trim.
RK11	Entrance		Latchbolt operated by knob/lever either side except when outside knob/lever is locked by turn-button inside. When outside knob/lever is locked, latchbolt operated by key outside or turning inside knob/lever. Inside button must be manually released.
RK12	Storeroom		Outside knob/lever always rigid. Latchbolt operated by key in outside knob/lever, or by turning inside knob/lever.
RK17	Classroom		Latchbolt operated by knob/lever either side except when key outside locks outside lever. Inside lever always free. Key outside locks/unlocks outside lever only.
			Indicates knob/lever rigid at all times.

How To Order:

Example: To order a RK Series entry function lockset with a Ball design lever, satin stainless steel finish, with a R60 strike, and 2-3/4" deadlocking latch, keyed different:

Specify:

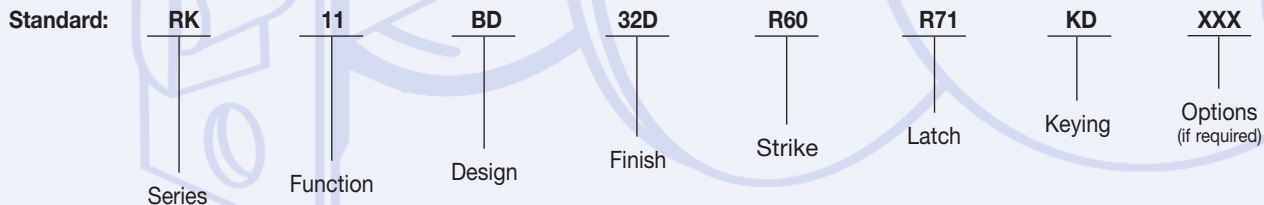

RK Series Cylindrical Locksets

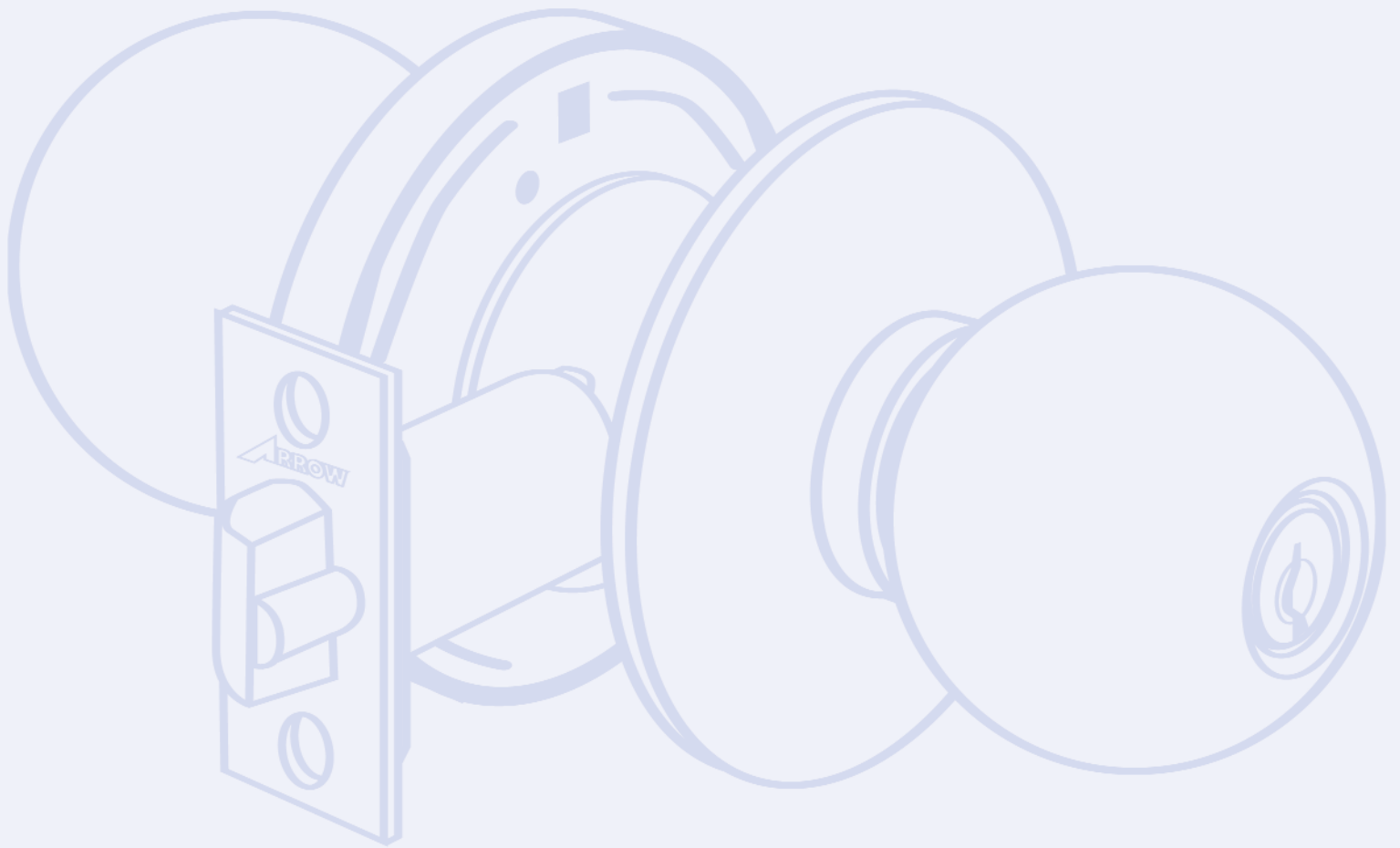

RK Series Cylindrical Locksets

ASSA ABLOY, the global leader
in door opening solutions



ASSA ABLOY

D Series deadbolts

Arrow D Series deadlocks are engineered to perform under the most extreme conditions where security is critical. Our Grade 1 extra heavy duty deadlock surpasses the demands of industrial, institutional and commercial applications.

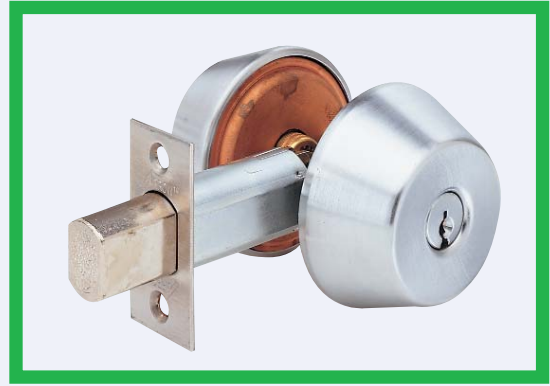

General Specifications

Housing—Two-piece housing, with free-spinning outer ring to prevent wrenching. Concealed mounting screws are standard on double cylinder functions.

Deadbolt—1" (25.40mm) throw, solid steel deadbolt with hardened, free spinning, steel pin & insert.

Backset—2-3/8" (60.32mm), 2-3/4" (69.85mm).

Deadbolt fronts—2-1/4" (57.15mm) x 1" (25.40mm) standard for 2-3/8" (60.32mm) backset, 2-1/4" (57.15mm) x 1-1/8" (28.57mm) standard for 2-3/4" (69.85mm) backset. Drive-in deadbolts are available.

Doors—1-3/8" (34.925mm) to 1-3/4" (44.45mm) thick standard.

Strikes—Supplied standard with #345 Security strike for steel frame, #346 security strike for wood frame and BX91D strike reinforcement.

Handing—All functions are reversible.

Cylinder, Standard—Solid brass, Arrow "A" keyway, 6 pin cylinder. Supplied with two nickel silver keys.

Cylinder Options—Accepts 6 or 7 pin, small format, interchangeable cores. Supplied less cores. Will accept Best™ or Falcon™ type cores (except the E41).

Finishes

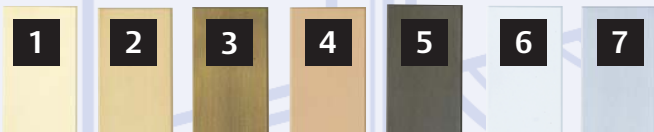

	BHMA	U.S. Equivalent	Arrow Equivalent	Finish
1	605	US3	03	Bright Brass
2	606	US4	04	Satin Brass
3	609	US5	05A	Antique Brass
4	612	US10	10	Satin Bronze
5	613	US10B	10B	Dark Oxide Bronze, Oil Rubbed
6	625	US26	26	Bright Chromium Plated
7	626	US26D	26D	Satin Chromium Plated

Certification & Compliance

- ANSI A156.5, Auxiliary Locks, Grade 1
- Underwriters Laboratories (UL and CUL) listed for use on A label or lesser doors when used in conjunction with a rated primary latching device

D Series Deadbolts

D Series deadbolts

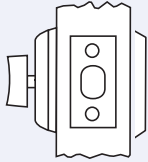
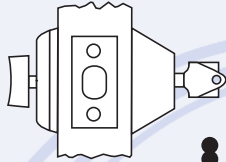
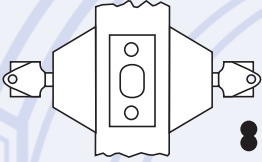
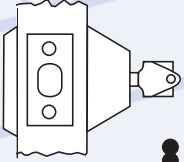
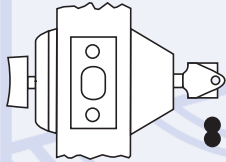
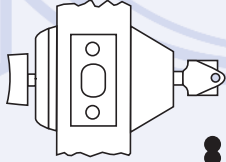
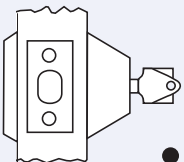
Arrow	ANSI		Function	Description/Operation
D60	E01111		Exit	Dead bolt operated by turn piece from inside. Blank plate on outside.
D61	E0151		Single Cylinder	Dead bolt operated by key from outside and by turn piece from inside.
D62	E0141		Double Cylinder	Dead bolt operated by key from either side.
D63	E0161		Single Cylinder	Dead bolt operated by key from outside. Blank plate inside.
D64	E0171		Classroom	Dead bolt operated by key from outside. Turn piece retracts dead bolt but does not project it.
D71-IC	E0151		Single Cylinder IC Only	Dead bolt operated by key from outside and by turn piece from inside. Concealed screws.
D73-IC	E0161		Single Cylinder IC Only	Dead bolt operated by key from outside. Blank plate inside. Concealed screws.

D Series Deadbolts

E Series deadbolts

Arrow E Series deadlocks are unsurpassed for value, quality and durability. Our tamper resistant rotating wrench-proof collar, steel deadbolt with hardened steel pin insert and concealed screws are security features that have made the E Series the most specified deadlock in its class.



General Specifications

Housing—Two-piece housing, with free spinning outer ring to prevent wrenching. Concealed mounting screws standard on double cylinder functions.

Thru-bolting—supplied with two 1/4" (6.35mm) steel thru-bolts.

Deadbolt—1" (25.40mm) throw, solid steel deadbolt with hardened, free spinning, steel pin insert.

Backset—2-3/8" (60.32mm), 2-3/4" (69.85mm), E41 backset is 2" (60.32mm) - 2-3/4" (69.85mm)

Deadbolt fronts—2-1/4" (57.15mm) x 1" (25.40mm) standard for 2-3/8" (60.32mm) backset, 2-1/4" (57.15mm) x 1-1/8" (28.57mm) standard for 2-3/4" (69.85mm) backset. Drive-in deadbolts are available.

Doors—1-3/8" (34.925mm) to 1-3/4" (44.45mm) thick standard.

Strikes—Supplied standard with two strikes. #345 security strike for steel frame. #346—security strike for wood frame.

Handing—All functions are reversible.

Cylinder, Standard—Solid brass, Arrow "A" keyway, drilled for 6 pins, pinned to 5. E41 is available in 5 pin. Supplied with two brass keys.

Cylinder Options—Accepts 6 or 7 pin, small format, interchangeable cores. Supplied less cores. Will accept Best™ or Falcon™ type cores.

Finishes

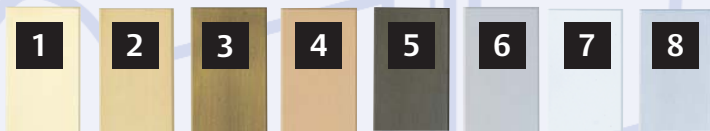

	BHMA	U.S. Equivalent	Arrow Equivalent	Finish
1	605	US3	03	Bright Brass
2	606	US4	04	Satin Brass
3	609	US5	05A	Antique Brass
4	612	US10	10	Satin Bronze
5	613	US10B	10B	Dark Oxide Bronze, Oil Rubbed
6	619	US15	15	Nickel Plated
7	625	US26	26	Bright Chromium Plated
8	626	US26D	26D	Satin Chromium Plated

Certification & Compliance

- ANSI A156.5, Auxiliary Locks, Grade 2
- Underwriters Laboratories (UL and CUL) listed for use on A label or lesser doors when used in conjunction with a rated primary latching device.

E Series Deadbolts

E Series deadbolts

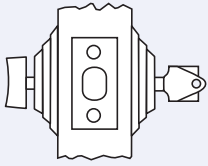
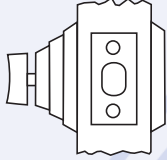
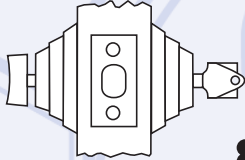
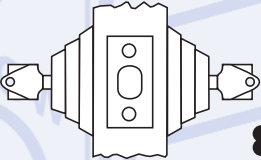
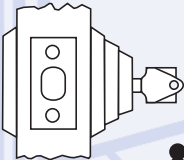
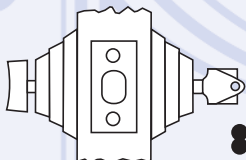
Arrow	ANSI		Function	Description/Operation
E41	E0141		Single Cylinder	Dead bolt operated by key from outside and by turn piece from inside.
E60	E01112		Exit	Dead bolt operated by turn piece from inside. Blank plate on outside.
E61	E0152		Single Cylinder	Dead bolt operated by key from outside and by turn piece from inside.
E62	E0142		Double Cylinder	Dead bolt operated by key from either side.
E63	E0162		Single Cylinder	Dead bolt operated by key from outside. Blank plate on inside.
E64	E0172		Classroom	Dead bolt operated by key from outside. Turn piece retracts dead bolt but does not project it.

E Series Deadbolts

N Series deadlock

Arrow N Series Mortise deadlock security and mortise cylinder convenience with interchangeable core compatibility.



General Specifications

Housing—Heavy wrought steel with zinc dichromate finish.

Deadbolt—1" (25.40mm), throw solid brass deadbolt with hardened steel pin.

Backset—2-3/4" (69.85mm).

Doors—1-3/8" (34.92mm) to 1-3/4" (44.45mm) thick standard.

Strikes—Supplied standard with #380 security strike for steel frame and #356 security strike for wood frame.

Handing—All functions are reversible.

Cylinder, Standard accepts standard 1-1/8" mortise cylinder—Solid brass, Arrow "A" keyway, drilled for 6 pins, pinned to 5. Supplied with two brass keys.

Cylinder Options—Accepts 6 or 7 pin, small format, interchangeable cores. Supplied less cores. Will accept Best™ or Falcon™ type cores. ASSA high security cylinders are available.

Certification & Compliance

- Underwriters Laboratories (UL and CUL) listed for use on A label or lesser doors when used in conjunction with a rated primary latching device

N Series Deadlock

N Series deadlock

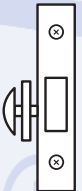
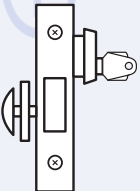
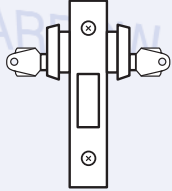
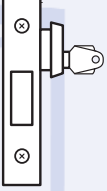
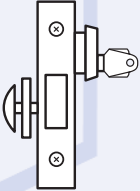
Arrow	ANSI	Function	Description/Operation
N40		Exit	Throw or retract bolt by thumbturn only.
N41		Single Cylinder	Throw or retract bolt by key outside, thumbturn inside.
N42		Double Cylinder	Throw or retract bolt by key either side.
N43		Single Cylinder	Throw or retract bolt by key one side.
N44		Classroom	Throw or retract bolt by key—Thumbturn retracts dead bolt, but does not project it.

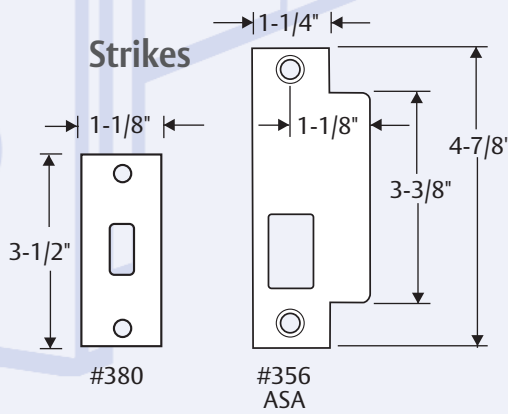

N Series Deadlock

Deadbolts

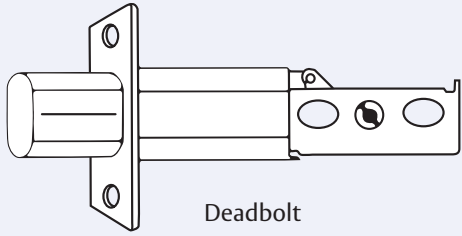

Deadbolt

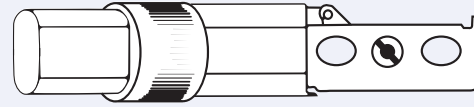

Drive-In Deadbolt

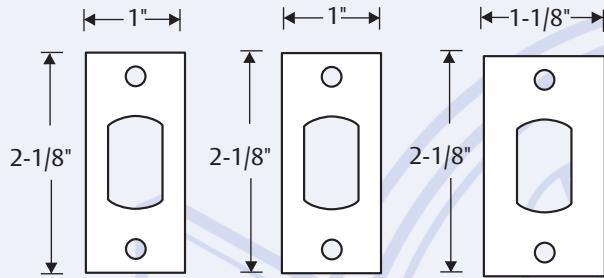

Part No.
Backset

#141
2-3/8"

#142
2-3/4"

#144
2-3/4"

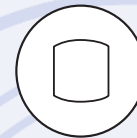

#145
2-3/8"

#146
2-3/4"

Strikes

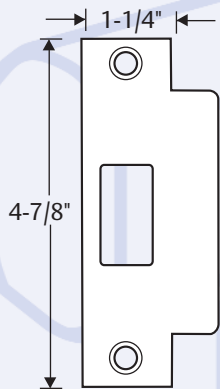

#347
ASA

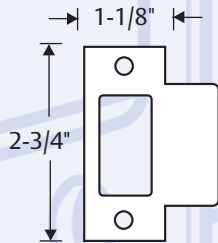

#350
T

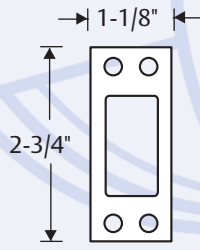

#345
(for metal doors)

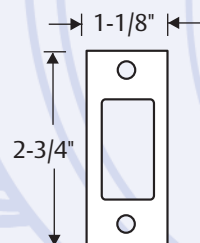

#346
(for wood doors)

#395
(includes both)

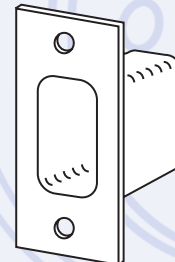

BX91D
(D Series)

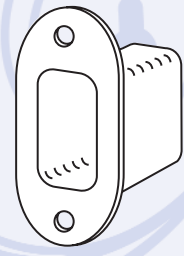

BX91
(E Series)

Parts

Thick Door Pack – For doors 2-1/4" thick

D, E, N Series Deadbolts

ASSA ABLOY, the global leader
in door opening solutions



ASSA ABLOY



LIGHT PRODUCTS											
PREMIER	SFIC	MORTISE LOCKS	CYLINDRICAL LEVERS	TUBULAR LOCKS	CYLINDRICAL KNOBS	DEADBOLTS	DOOR CLOSERS	INTER-CONNECTED LOCKS	ALARMED HARDWARE	E-DEVICE	
Palinto Palinto Key Palinto Locking Buttons Palinto Palinto Palinto Design	AM/SM GRADE 2 10 knob designs 12 lever designs 4 finishes IC core option	Q W ML L RL GRADE 2 17 functions (ML) 16 functions (ML) 3 lever designs 6 finishes IC core option IC core option	H S MR RK GRADE 2 10 functions (H) 13 functions (S) 4 designs (MR) 2 designs (RK) 16 finishes (H) 2 finishes (S) IC core option	D E GRADE 2 2 functions 7 finishes IC core option	300N 5016N GRADE 1 11 styles (300N) 3 finishes	JL GRADE 2 4 functions 7 finishes IC core option	100 300 400 500 1000 GRADE 2 4 hardware finishes 3 finishes Round case (100) Palinto (300) Palinto (400)	100 300 400 500 1000 GRADE 2 4 functions 7 finishes IC core option	100 300 400 500 1000 GRADE 2 2 styles: rim & SVR (1200) 3 styles: mortise, rim & SVR (1700) 4 finishes (1200) 6 finishes (1700)		
CLASSIC Palinto Palinto Palinto Palinto Design	AM/SM GRADE 2 10 knob designs 12 lever designs 4 finishes IC core option	Q W ML L RL GRADE 2 17 functions (ML) 16 functions (ML) 3 lever designs (ML) 6 finishes IC core option IC core option	H S MR RK GRADE 2 17 functions 16 functions (H) 4 designs (MR) 2 designs (RK) 16 finishes (H) 2 finishes (S) IC core option	D E GRADE 2 2 styles (41&61) 6 functions (E1) 1 function (E2) 7 finishes IC core option (E1)	300N 5016N GRADE 1 11 styles (300N) 3 finishes	JL GRADE 2 4 functions 7 finishes IC core option	100 300 400 500 1000 GRADE 2 4 hardware finishes 3 finishes Round case (100) Palinto (300) Palinto (400)	100 300 400 500 1000 GRADE 2 4 functions 7 finishes IC core option	100 300 400 500 1000 GRADE 2 2 styles: rim & SVR (1200) 3 styles: mortise, rim & SVR (1700) 4 finishes (1200) 6 finishes (1700)		
VALUE Palinto Palinto Palinto Palinto Design	AM/SM Grade 2 7 functions 2 lever designs 6 finishes IC core option	Q W ML L RL Grade 2 6 functions 4 lever designs 3 knob designs 5 finishes IC core option	C Grade 2 6 functions 1 design 6 finishes IC core option	H S MR RK Grade 2 6 functions 1 design 6 finishes IC core option	D E Grade 1 2 styles: rim & SVR 2 finishes	300N 5016N Grade 1 2 styles: rim & SVR 2 finishes	100 300 400 500 1000 1500 Grade 1 2 styles: rim & SVR 2 finishes	100 300 400 500 1000 1500 Grade 1 2 styles: rim & SVR 2 finishes	100 300 400 500 1000 1500 Grade 1 2 styles: rim & SVR 2 finishes		

Door Closers

900N, 5016N, DC200 Series

ASSA ABLOY, the global leader in door opening solutions



The Arrow 900N Series Surface Applied Door Closers are ideal for dealers or end users looking for value and versatility in a compact design. The adjustable spring sizes and ADA barrier free accessibility make this Series ideally suitable for a wide variety of applications.



Certification

All 900N Series closers are U.L. and C.U.L. listed for use on 3 hour or lesser doors. They conform to the requirements of ANSI A156.4, Grade 1, and meet the requirements of UL10C and UBC7.2 (1997) for positive pressure.

ADA/Americans with Disabilities Act

914N closers meet the standard of ANSIA117.1 for barrier free accessibility



Look for the universal symbol next to Arrow products that comply with ADA accessibility requirements.

Features

- 914N – Adjustable for spring sizes 1-4. Meets 5lbs., maximum opening force for interior doors, and 8.5lbs., maximum opening force for exterior doors.
- 936N-Adjustable for spring sizes 3-6 to meet a variety of on-site conditions.
- Non-handed for regular, top jamb and parallel arm mount applications.
- Two non-critical adjusting valves (sweep and latch) work to provide consistent closing speeds through a wide range of temperatures.
- Packaging: 1 per box, 6 per master carton.
- Warranty: 10 years.

Finishes:

Finishes:

- Aluminum (689) AL,
- Dark Bronze (690) DBZ
- Light Bronze (691) LBZ
- Gold (696) GL
- Black (693) BLK

900N Series Door Closers

ASSA ABLOY, the global leader
in door opening solutions



ASSA ABLOY

900N Series Hold Open

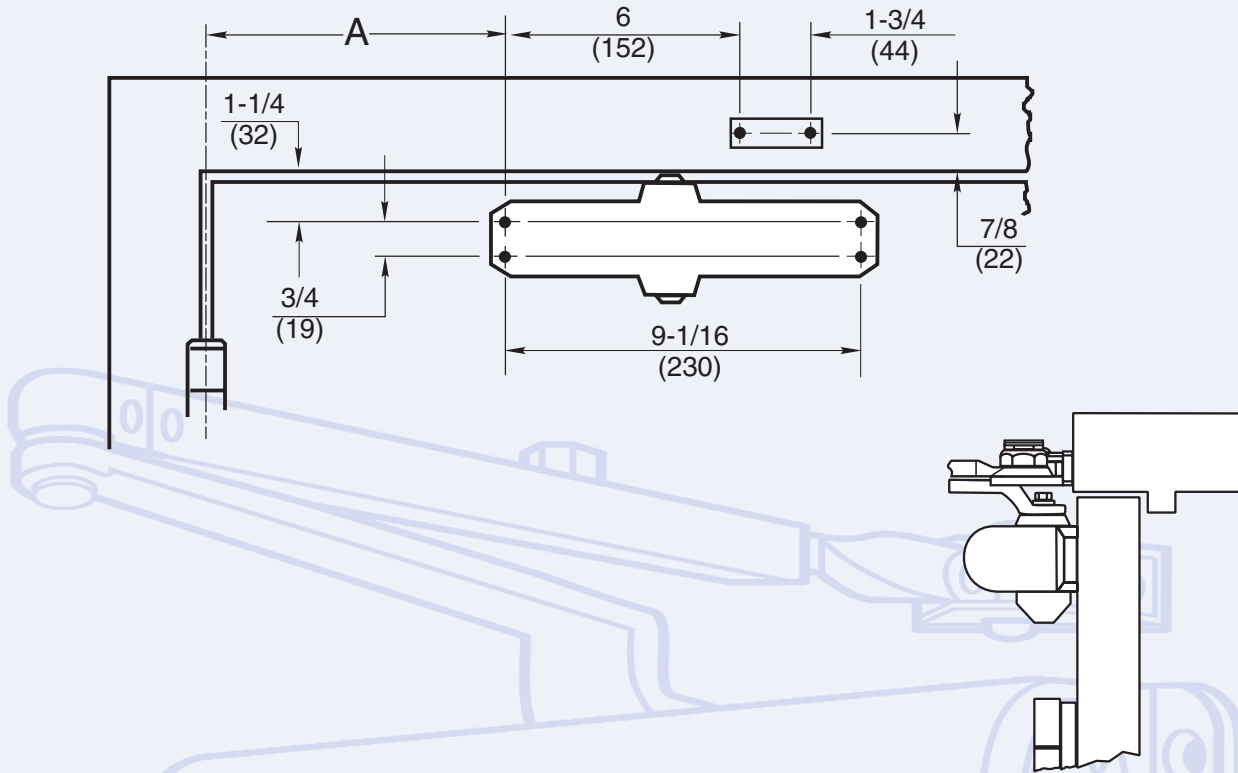

How to order the 900N Series

COMPLETE UNITS

Tri-Pack, Standard Arm, Sizes 1-4	914N
Tri-Pack, Standard Arm, Sizes 3-6	936N
Tri-Pack, Hold Open Arm, Sizes 3-6.....	936NH
Tri-Pack, Hold Open Arm, Sizes 1-4.....	914NH

PARTS & ACCESSORIES

Drop Plate	936DP
914N Closer Body Only	914BO
936N Closer Body Only	936BO
Through-Bolts for 1-3/8" Thick Door	5016TB38
Through-Bolts for 1-3/4" Thick Door	5016TB34
Complete Non-Hold Open Arm Assembly (tri-pack)	5016CNA
Complete Hold Open Arm Assembly (tri-pack)	5016CHA

Specify Finish: AL, DBZ, LBZ, GL, or BLK

900N Series Door Closers

ASSA ABLOY, the global leader
in door opening solutions



ASSA ABLOY

The Arrow 5016N Series Surface Applied Door Closers are ideal for use in commercial and institutional facilities where there is a demand for reliability and flexibility. Arrow offers multiple options for compliance with barrier-free codes for interior or exterior doors.



Certification

The 5016N Series closers are U.L. and C.U.L. listed for use on 3 hour or lesser doors. They are certified to the requirements of ANSI A156.4, Grade 1, and meet the standards for UL10C and UBC7.2 (1997) for positive pressure.

ADA/Americans with Disabilities Act

5016N Series meets the standards of ANSIA117.1 for barrier free accessibility.

 **Look for the universal symbol next to Arrow products that comply with ADA accessibility requirements.**

Features

- Adjustable for spring sizes 1-6. Meets 5lbs., maximum opening force for interior doors, and 8.5lbs., maximum opening force for exterior doors.
- Adjustable backcheck is standard. Provides cushioning for uncontrolled door openings.
- Backcheck positioning valve is standard. Maintains effective backcheck range on parallel arm applications. The valve is accessible while the closer is installed.
- Available with optional delayed action adjusted with separate independent valve. Delays door closing to allow unimpeded passage through the opening.
- Available with streamline or full plastic cover
- Designed to minimize change in closing speed during severe temperature changes.
- Non-handed for regular, top jamb and parallel arm mount applications.
- Packaging: 1 per box, 6 per master carton.
- Warranty: 10 years.

Finishes:

Finishes:

- Aluminum (689) AL,
- Dark Bronze (690) DBZ
- Light Bronze (691) LBZ
- Gold (696) GL
- Black (693) BLK

5016N Series Door Closers

5016N Series Hold Open

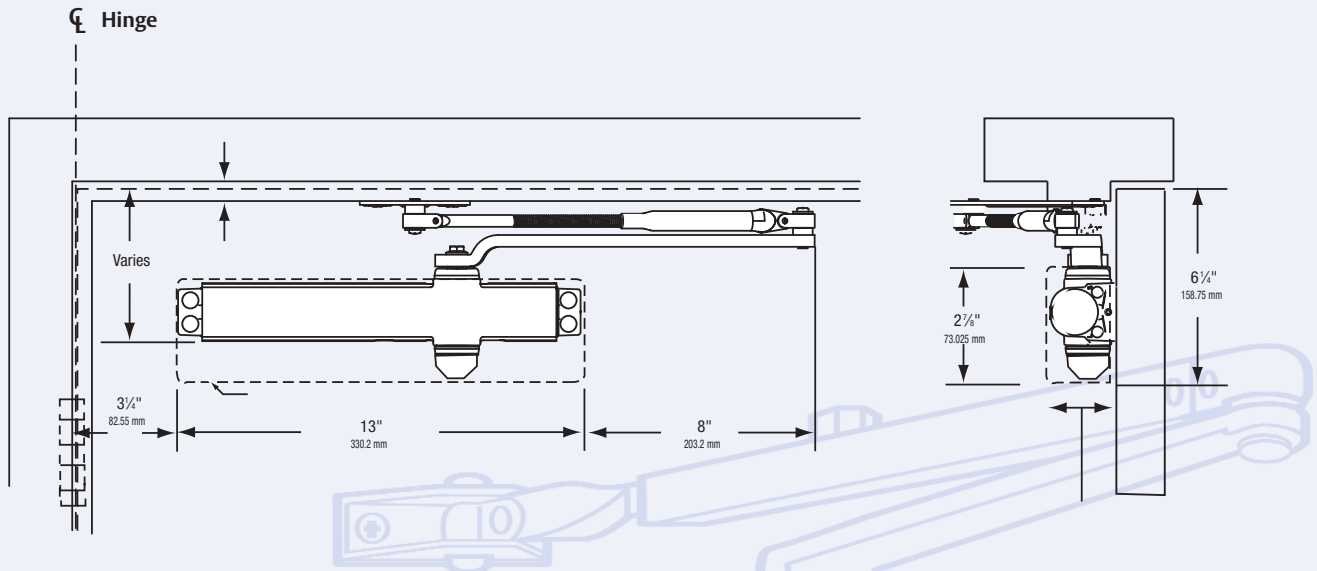

How to order the 5016N Series

COMPLETE UNITS

Tri-Pack, Slim Plastic Cover, Standard Arm, Sizes 1-6.....	5016NS
Tri-Pack, Full Plastic Cover, Standard Arm, Sizes 1-6	5016N
Tri-Pack, Slim Cover, Standard Arm, Sizes 1-6, Delayed Action	5016NSD
Tri-Pack, Full Cover, Standard Arm, Sizes 1-6, Delayed Action	5016ND
Tri-Pack, Slim Plastic Cover, Hold Open Arm, Sizes 1-6.....	5016NSH
Tri-Pack, Full Plastic Cover, Hold Open Arm, Sizes 1-6.....	5016NH
Tri-Pack, Slim Plastic Cover, Hold Open Arm, Sizes 1-6, Delayed Action.....	5016NSHD
Tri-Pack, Full Plastic Cover, Hold Open Arm, Sizes 1-6, Delayed Action	5016NHD

PARTS & ACCESSORIES

Drop Plate.....	5016DP
Full Plastic Cover	5016FC
Streamline Plastic Cover	5016SC
5016N Closer Body Only	5016BO
5016N Closer Body Only with Delayed Action	5016BOD
Through-Bolts for 1-3/8" Thick Door	5016TB38
Through-Bolts for 1-3/4" Thick Door	5016TB34
Complete Non-Hold Open Arm Assembly (tri-pack).....	5016CNA
Complete Hold Open Arm Assembly (tri-pack).....	5016CHA

Specify Finish: AL, DBZ, LBZ, GL, or BLK

5016N Series Door Closers

ASSA ABLOY, the global leader
in door opening solutions



ASSA ABLOY

The Arrow DC200 Series surface applied door closers are an economical value for customers requiring convenience and security in an affordable package. They are ideally suited for retail or office buildings.

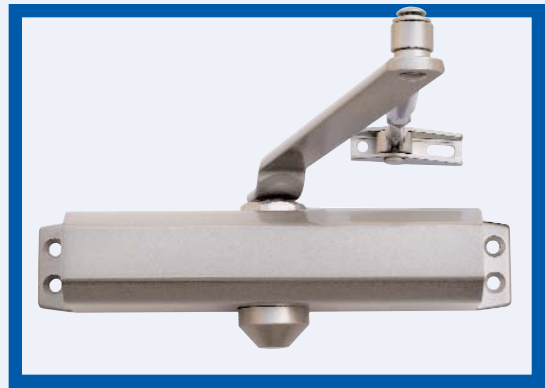

Certification:

All DC200 Series closers are U.L. and C.U.L. listed for use on 3 hour or lesser doors.

ADA/Americans with Disabilities Act:

DC200 Series closers meet the standard of ANSIA 117.1 for barrier free accessibility.

 Look for the universal symbol next to Arrow products that comply with ADA accessibility requirements.

Features:

- DC214 – Adjustable sizes 1 through 4. Door closers to meet handicapped requirements or for light through medium weight interior doors
- DC203 – Fixed size 3 for interior doors, light duty
- DC204 – Fixed size 4 for wide heavy exterior doors, heavy duty
- Non-handed for regular, top jamb and parallel arm mount applications.
- Two non-critical adjusting valves (sweep and latch) work to provide consistent closing speeds through a wide range of temperatures.
- Springs: High tensile steel springs
- Spindle: Hardened steel rack and pinion
- Warranty: 10 years.

DC203/DC204

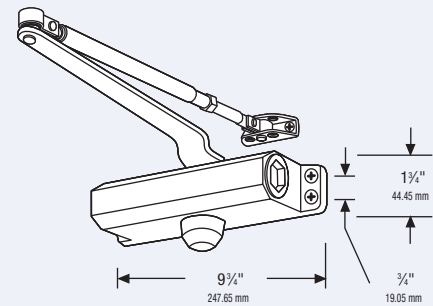

DC214

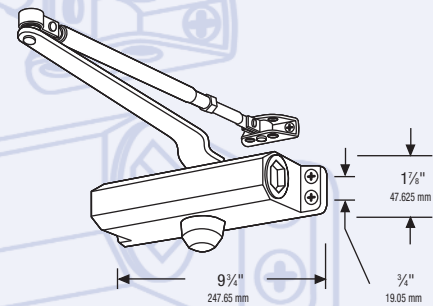

Finishes:

- Aluminum (689) AL
- Dark Bronze (690) DBZ

How to order the DC200 Series:

Complete Units

Adjustable size 1-4 x 689 finish	DC214.AL
Adjustable size 1-4 x 690 finish	DC214.DBZ
Fixed Size 3 x 689 finish.....	DC203.AL
Fixed Size 3 x 690 finish.....	DC203.DBZ
Fixed Size 4 x 689 finish.....	DC204.AL
Fixed Size 4 x 690 finish.....	DC204.DBZ

DC200 Series Door Closers



RIGHT PRODUCTS

	CLASSIC	MORTISE LOCKS	CYLINDRICAL LEVERS	TUBULAR LOCKS	CYLINDRICAL KNOBS	DEADBOLTS	DOOR CLOSERS	INTER-CONNECTED LOCKS	ALARMED HARDWARE	EXIT DEVICES	
CLASSIC	Points Baker brass contour lock antique wavy design	Grade 2 17 functions (ML) 2 lever designs 3 lever designs (ML) 2 lever design (L) 10 finishes Overlives Option (AR) IC core option (ML)	Grade 2 17 functions (ML) 2 lever designs 3 lever designs (ML) 2 lever design (L) 10 finishes Overlives Option (AR) IC core option (ML)	Grade 2 17 functions (ML) 2 lever designs 3 lever designs (ML) 2 lever design (L) 10 finishes Overlives Option (AR) IC core option (ML)	Grade 2 17 functions (ML) 2 lever designs 3 lever designs (ML) 2 lever design (L) 10 finishes Overlives Option (AR) IC core option (ML)	Grade 2 17 functions (ML) 2 lever designs 3 lever designs (ML) 2 lever design (L) 10 finishes Overlives Option (AR) IC core option (ML)	Grade 2 17 functions (ML) 2 lever designs 3 lever designs (ML) 2 lever design (L) 10 finishes Overlives Option (AR) IC core option (ML)	Grade 2 17 functions (ML) 2 lever designs 3 lever designs (ML) 2 lever design (L) 10 finishes Overlives Option (AR) IC core option (ML)	Grade 2 17 functions (ML) 2 lever designs 3 lever designs (ML) 2 lever design (L) 10 finishes Overlives Option (AR) IC core option (ML)	Grade 2 17 functions (ML) 2 lever designs 3 lever designs (ML) 2 lever design (L) 10 finishes Overlives Option (AR) IC core option (ML)	Grade 2 17 functions (ML) 2 lever designs 3 lever designs (ML) 2 lever design (L) 10 finishes Overlives Option (AR) IC core option (ML)
VALUE	AM/DM	Q W ML L RL	C	H S MK RK	D E	900N 901N	L	100 300 400	300 3300 3000 4000 1700	300 3300 3000 4000 1700	

Interconnected Lock

JL Series

ASSA ABLOY, the global leader in door opening solutions



Offering safety and style, the JL Series Interconnected Lock is specifically engineered for institutional, retail and multiple dwelling applications including; apartment buildings, assisted living facilities hotels/motels schools and hospitals. The JL Series meets ANSI/BHMA A156.12 Grade 2 requirements, is UL Listed and complies with to ADA barrier-free accessibility codes.

Easy to install, the JL Series requires a standard bore for cylindrical lockset and deadlock – no mortising.

The deadbolt and lever lock offer independent function outside – while the inside lever is always free and retracts deadbolt and dead latch simultaneously for panic-free egress.

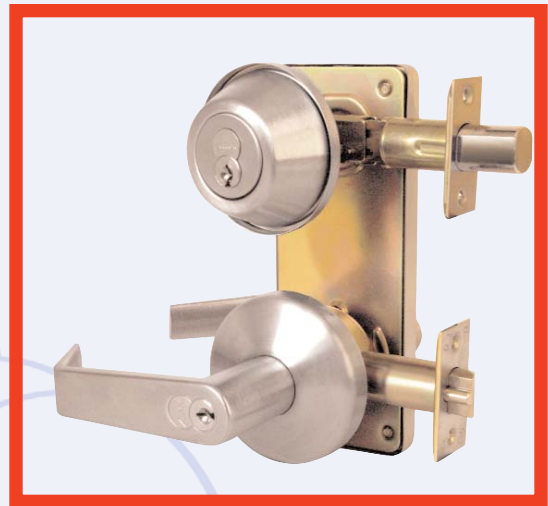

Specifications

For Doors	1-3/8" (35mm) adjusts to 1-3/4" (45mm) standard
Backsets	2-3/4" (70mm) standard 2-3/8" (60mm) optional
Trim	Non-handed – SR Sierra (IC core available) and BRR Broadway lever designs Handed – OR Orion lever design
Roses/Escutcheon	3" dia. (89mm) Wrought brass or bronze - concealed mounting screws
Deadlatch	Brass, 1/2" (13mm) throw, 2-1/4" (57mm) x 1-1/8" (29mm) for 2-3/4" backset 2-1/4" (57mm) x 1" (25mm) for 2-3/8" backset
Deadbolt	Brass, 1" (25mm) throw with hardened steel bar
Cylinder	Brass, 6 pin, Arrow A keyway standard, competitive keyway available, IC, SR Sierra only
Keys	Two; nickel silver
Masterkeying	Can be master keyed or grand master keyed. Construction key systems available.
Finishes	US3, US4, US10, US10B, US15, US26, US26D and Split Finishes are available
Minimum Stile	4-1/2" (114mm) with 2-3/4" backset 4 1/4" (108mm) with 2-3/8" backset
Door Prep	Standard template 4 on center

Certification & Compliance

UL	Underwriters Laboratories (UL & CUL) Listed, For use on 3 hour, A label single swinging doors
Positive Pressure	Meets UL 10C and UBC 7-2 (1997)
ADA	All levers conform to ADA requirement for barrier-free accessibility

JL Series Interconnected Lock



Arrow	Function		ANSI	Description
01	Passage		F95	Operate deadlatch by lever either side. Turning inside lever retracts deadlatch and deadbolt simultaneously. Deadbolt activated by thumbturn inside or key outside. Both levers always free.
11	Entrance/Office Double Locking		F97	Operate deadlatch by lever either side. Thumbturn inside locks outside lever. Key outside retracts deadlatch when locked. Turning inside lever retracts deadlatch and deadbolt simultaneously. Inside lever always free. Deadbolt activated by thumbturn inside or key outside.
12	Storeroom Double Locking		F98	Operate deadlatch by lever inside only. Outside lever always rigid. Inside lever always free. Key outside retracts deadlatch. Turning inside lever retracts deadlatch and deadbolt simultaneously. Deadbolt activated by thumbturn inside or key outside.
17	Classroom Double Locking			Operate deadlatch by lever either side, except when key outside locks outside lever, inside lever always free. Key outside locks & unlocks outside lever only. Deadbolt activated by thumbturn inside or key outside.

JL Series Interconnected Lock

ASSA ABLOY, the global leader in door opening solutions



ASSA ABLOY

Deadbolt Components

#345 Strike	#JL-210 Deadbolt	#JL-210 Front - detail
	<p>Adjustable Backset 2-3/8" - 2-3/4"</p>	
Standard		

Cylindrical Lock Components

#300 Strike	#306 Strike	#302 Strike
Deadlatch	#121 Deadlatch	#124 Deadlatch
	<p>Backset 2-3/8"</p>	<p>Backset 2-3/4"</p>

JL Series Interconnected Lock

ASSA ABLOY, the global leader in door opening solutions



ASSA ABLOY



THE RIGHT PRODUCTS

WE ARE PROUD TO RECOMMEND **ARROW**

SPIC	MORTISE LOCKS	CYLINDRICAL LEVERS	TUBULAR LOCKS	CYLINDRICAL KNOBS	DEADBOLTS	DOOR CLOSERS	INTER-CONNECTED LOCKS	ALARMED HARDWARE	EXIT DEVICES
PREMIER <i>Pointe Flax</i>	AM/DB	Q W ML L RL	C	H S MK RR	D E	900N 5016N	JL	100 300 400	500 1000 3000 4000 1700
<ul style="list-style-type: none"> Patented Key-Cushion Universal Return Soft Press Conventional Recessed Sliver Design 	<ul style="list-style-type: none"> GRADE 3 29 Functions 150 Knob Designs 21 Lever Designs 8 Finishes 	<ul style="list-style-type: none"> GRADE 2 17 Functions (Q) 24 Functions (W) 3 Lever Designs 8 Finishes Overdrive option IC core option 	<ul style="list-style-type: none"> GRADE 1 20 Functions (H) 13 Functions (S) 4 Designs (MK) 2 Handles (D) 8 Finishes (RR) 2 Finishes (E) IC core option 	<ul style="list-style-type: none"> GRADE 1 2 Functions 7 Finishes IC core option 	<ul style="list-style-type: none"> GRADE 1 standard in both cases 3 Finishes 	<ul style="list-style-type: none"> GRADE 5 3 Finishes 4 hardware finishes 3 handles Stand alone (100) Panel (300) TouchKey (400) 	<ul style="list-style-type: none"> GRADE 1 4 styles: mortise, rim, SVR, CVR (3000) 3 styles: mortise, rim & SVR (4000) 7 finishes (2000) 6 finishes (4000) 		
CLASSIC <i>Pointe</i>	AM/ML	Q W ML L RL	C	H S MK RR	D E	900N 5016N	JL	100 300 400	500 1000 3000 4000 1700
<ul style="list-style-type: none"> Solid back construction Recessed sliver design 	<ul style="list-style-type: none"> GRADE 2 17 Functions (ML) 7 Functions (L) 3 lever designs (ML) 2 lever designs (L) 6 Finishes Overdrive Option (ML) IC core option (ML) 	<ul style="list-style-type: none"> GRADE 2 17 Functions 6 designs 7 finishes IC core option 	<ul style="list-style-type: none"> GRADE 2 17 Functions 2 styles (d1&d2) 6 finishes (d1) 1 function (H1) 7 finishes IC core option (d1) 	<ul style="list-style-type: none"> GRADE 2 4 functions 3 lever designs 7 finishes IC core option 	<ul style="list-style-type: none"> GRADE 1 2 styles: rim & SVR (1250) 3 styles: mortise, rim & SVR (1700) 4 finishes (1250) 6 finishes (1700) 				
VALUE	AM/ML	Q W ML L RL	C	H S MK RR	D E	900N 5016N	JL	100 300 400	500 1000 3000 4000 1700
		<ul style="list-style-type: none"> Grade 2 7 functions 2 lever designs 6 finishes IC core option 	<ul style="list-style-type: none"> Grade 2 6 functions 4 lever designs 3 knob designs 3 finishes 	<ul style="list-style-type: none"> Grade 2 6 functions 1 designs 6 finishes IC core option 			<ul style="list-style-type: none"> Grade 1 2 styles: rim & SVR 2 finishes 		

Alarmed Hardware

100, 300, 400 Series

ASSA ABLOY, the global leader in door opening solutions



100 Series exit alarm

General Specifications

Chassis–Non-ferrous alloy cover and base, 8-3/8" (212.72 mm) x 2" (50.8 mm) x 2-5/8" (66.67 mm). Tamper-proof cover screw sets unit into alarm upon unauthorized removal of the cover.

Power/Electronics–9 volt battery powered. Modern, solid state electronics. Magnet activated.

Doors–For inward or outward swinging doors with 4" minimum stile.

Alarm/Horn–Alarm sounds for 2 minutes, shuts off and automatically rearms itself. Piercing, high frequency horn. Rated for 90 decibels at 6 feet.

Cylinders–Inside cylinder operation to arm or disarm unit using 1-1/8" (28.57 mm) mortise cylinder. Outside rim cylinder operation standard. (Order cylinders separately).

Hand–Non-handed.

Features

110 Series–Push button test to determine available battery power.

130 Series–15 second delay upon arming permits key holder to exit door without sounding alarm. Low battery alert causes unit to chirp intermittently to indicate low battery power.

Red LED indicator flashes when violation occurs. Light continues to flash beyond alarm cycle and can only be turned off by the inside key.



Finishes

Powder coated painted finishes: AL BRZ, RD.

Hardware finishes: US10, US10B, US26, US26D.

300 Series exit alarm

General Specifications

Chassis–Paddle, chassis and cover made from a non-ferrous alloy. Cover 12-3/4" (323.85 mm) x 2" (50.8 mm) x 2-5/8" (66.67 mm); paddle projection 3-1/4" (88.25 mm); length to end of paddle 10-3/8" (263.52 mm).

Power/Electronics–9 volt battery powered. Modern solid state electronics.

Latch–3/4" (19.05 mm) latchbolt monitored by an electronic sensor switch. Any unauthorized movement of the latchbolt will cause unit to go into alarm.

Doors–For outward swinging doors 1-3/4" (44.45 mm) thick with a 4" minimum stile.

Alarm/Horn–Alarm sounds for 2 minutes, shuts off and automatically rearms itself. Piercing, dual frequency pulsating horns. Rated for 90 decibels at 6 feet.

Cylinders–Inside cylinder operation to arm or disarm unit using 1-1/8" (28.57 mm) mortise cylinder. (Order cylinder separately).

Hand–Reversible. Units are packed RHRB.

Features

Model 320–Auto relatching.

Red LED indicator flashes when violation occurs. Light continues to flash beyond alarm cycle and can only be turned off by the inside key.

One chassis will accept all available trim options.

Unit must be activated to test available battery power.

Model 330–Contains same features as the 320.

Low battery alert feature causes unit to chirp intermittently to indicate low battery power.



Finishes

Powder coated painted finishes: AL, BRZ, RD.

Hardware finishes: US10, US10B, US26, US26D.

Certification and Compliance



UL listed. Designed to meet ANSI 156.5-1984 and A117.1-1980 for Accessibility Standards.

Alarmed Hardware

ASSA ABLOY, the global leader
in door opening solutions

ARROW
LOCK & DOOR HARDWARE

ASSA ABLOY

400 Series exit alarm

General Specifications

Chassis—Chassis and cover made from a non-ferrous alloy, 12-3/4" (323.85 mm) x 2" (50.8 mm) x 2-5/8" (66.67 mm).

Touchbar—Rolled steel touchbar assembly to fit 30" (762.0 mm) to 36" (914.40 mm) door furnished standard. Bars to fit 24" (609.60 mm) to 30" (762.0 mm) and 37" (939.80 mm) to 48" (1219.20 mm) available. Can be cut to size in the field. Specify door width.

Power/Electronics—9 volt battery powered. Modern, solid state electronics.

Latch—3/4" (19.05 mm) latchbolt monitored by an electronic sensor switch. Any unauthorized movement of the latchbolt will cause the unit to go into alarm.

Doors—for outward swinging doors 1-3/4" (44.45 mm) thick with 4" (101.60 mm) minimum stile.

Horn/Alarm—Piercing, dual frequency pulsating horns. Rated for 90 decibels at 6 feet. Alarm sounds for two minutes then, shuts down and rearms automatically. A 15 second delay feature allows authorized egress without sounding alarm.

Cylinders—Inside cylinder operation to arm or disarm unit using a 1-1/8" (28.57 mm) mortise cylinder. (Order cylinder separately).

Hand—Reversible. Unit is packed RHRB.



Features

Model F420—Fire rated.

Model 420—Red LED indicator flashes when violation occurs. Light continues to flash beyond alarm cycle and can only be returned off by the inside key.

Units set up to accept outside cylinder operation as standard.

One chassis will accept all available trim options.

Unit must be activated to test available battery power.

Model F430—Fire rated.

Model 430—Contains same features of the 420.

Low battery alert feature causes unit to chirp intermittently to indicate low battery power.

Finishes

Powder coated painted finishes: AL, BRZ, RD.

Hardware finishes: US10, US10B, US26, US26D.

Certification and Compliance

UL listed for exit hardware. Also available UL rated for fire exit hardware (Prefix "F" to model number).

Designed to meet ANSI 156.3-1984 and A117.1-1980 for Accessibility Standards.

Packed - 1 each.

Trim

Exit Alarm Trim

Matching trim available to complement other series of cylindrical locks, BM Series Mortise locks, exit devices and alarms.

Ordering information:

When ordering trim, specify design symbol and function, eg: **BR12**, if specifying **Broadway** lever in **Storeroom** function.

Finishes

US3, US10, US10B, US26, US26D. (Knobs and levers)
AL, BRZ, RD. (SF Trim)

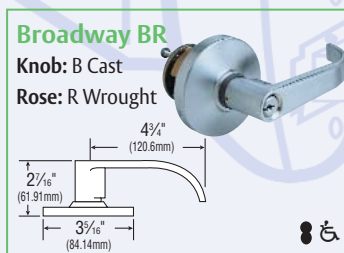
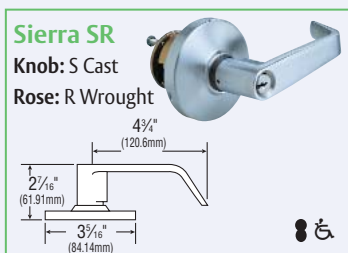
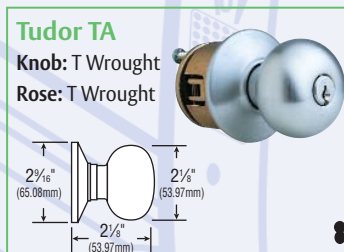
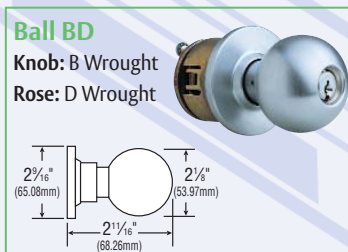

Alarmed Hardware

100, 300, 400 Series accessories

Thru Bolts

#S30 (300, 400 series, 1-3/4" doors).
 #S32 (F-400 series, 1-3/4" doors).
 Specify finish: AL, BRZ.
 To add extra strength to mounting.

Narrow Stile Mounting Plates

#S73 (100 series).
 #S74 (300 series).
 #S75 (400 series).
 Specify finish: AL, BRZ.
 For doors with stile widths 1-3/4"-4".
 Not for use with F-400 series.

Options

Automatic Rearming

- Units are provided with spring loaded on/off switch. Switch automatically returns to the on position after removal of the key.
- Alarm can never be left off.
- Available for all alarm models.
- Prefix AR to catalog number.

Remote Monitor

- Alarm units are supplied with 8-foot leads of wire. Wire attached to the electronics assembly to allow monitoring from a remote location.
- Can be used in conjunction with Arrow S40 remote panel or with panel, light or bell provided by others.
- Closed loop circuitry provides highest security.
- Prefix RM to catalog number (not available on 110 or 130 models).

Strikes

S38
 300/400 Series standard for single door applications.
 Black nylon coated.

S24
 F-400 Series standard for single door applications.
 Black nylon coated.

S36
 300/400 Series for double door applications without a mullion.
 Surface applied. Black nylon coated.

Surface Magnet Pack

#580 Magnet and shim for 100 series (furnished with alarm).

Functions

- 01 Passage** – Knob always active. Turning knob retracts latch and puts alarm into 15 second delay mode. (Latch retraction by knob sets off alarm is optional).
- 08 Dummy Trim** – Single pull only.
- 12 Storeroom** – Knob always rigid. Key retracts latch and puts alarm into 15 second delay mode.
- 17 Classroom** – Key locks or unlocks knob. Turning knob retracts latch and puts alarm into 15 second delay mode.

Continuous Alarm

- Horns will sound continuously after a violation has occurred—does not shut off after 2 minute alarm cycle.
- Only disarming by key operation will quiet the alarm.
- Remote power is recommended for units with this feature.
- Prefix CA to catalog number (not available on 110 or 130 models).

Remote Power

- Alarm units are supplied with 8-foot leads of wire. Wire attached to electronics assembly to power unit from an external source.
- Can be used in conjunction with Arrow S63 Hard Wired Battery Eliminator or by other remote 9V power source.
- Prefix RP to catalog number (not available on 110 and 130 models).



Exit Devices

3000, 4000, S1000, 1700, 500 Series

ASSA ABLOY, the global leader in door opening solutions





General Specifications

	3600	3700	3880	3900
Chassis	Non-ferrous alloy	Non-ferrous alloy	Non-ferrous alloy	Non-ferrous alloy
Chassis cover	Cold drawn brass, bronze or stainless steel	Cold drawn brass, bronze or stainless steel	Cold drawn brass, bronze or stainless steel	Cold drawn brass, bronze or stainless steel
Door Types	Hollow metal or aluminum	Wood or metal	Wood or metal	Wood or Metal
Door Thickness	1-3/4" (44.45mm) standard	1-3/4" (44.45mm) standard up to 2-1/4" (57.15mm) available	1-3/4" (44.45mm) standard up to 2-1/4" (57.15mm) available	1-3/4" (44.45mm) standard up to 2-1/4" (57.15mm) available
Stile	4-1/2" (144.30mm) minimum	4-1/2" (144.30mm) minimum with trim, 3-1/2" (88.90mm) minimum without trim.	See trim page for stile dimensions	4-1/2" (144.30mm) minimum
Mounting	Supplied with machine screws	Supplied with wood and machine screws. Available with thru bolts.	Supplied with wood and machine screws. Available with thru bolts	Supplied with wood and machine screws. Available with thru bolts.
Handing	Handed. Specify LHRB or RHRB	Handed. Specify LHRB or RHRB	Handed. Specify LHRB or RHRB	Handed. Specify LHRB or RHRB.
Dogging	Allen type standard. Available with cylinder dogging (suffix "CD")	Allen type standard. Available with cylinder dogging (suffix "CD")	Allen type standard. Available with cylinder dogging (suffix CD)	Allen type standard. Available w/ cylinder dogging (suffix CD)
Top/Bottom Bolts	Stainless Steel	Brass	N/A	N/A
Latchbolt	N/A	N/A	Stainless steel, 3/4" (19.05mm) throw	Brass, 3/4" (19.05mm) throw
Rail	Roll-formed brass, bronze or stainless steel	Roll-formed brass, bronze or stainless steel	Roll-formed brass, bronze or stainless steel	Roll-formed brass, bronze or stainless steel
Rail Projection	3-1/4" (82.55mm) maximum	3-1/4" (82.55mm) maximum	3-1/4" (82.55mm) maximum	3-1/4" (82.55mm) maximum
Opening Height	96" (2438.40mm) standard	90" (2286.00mm) standard	N/A	N/A
Fire Exit Hardware-up to:	4' x 10' single door 8' x 10' pairs of doors	4' x 8' single door 8' x 8' pairs of doors	4' x 8' single door 8' x 8' pairs of doors with S21 mullion.	4' x 10' single 8' x 10' pairs of doors (with 3600-FR) 8' x 8' pairs of doors (with 3700-FR)
Trim	See trim pages 15, 16	See trim pages 15, 16	See trim pages 15, 16	See trim pages 15, 16
Finishes	AL, US3, US4, US10, US10B, US32, US32D	AL, US3, US4, US10, US10B, US32, US32D	AL, US3, US4, US10, US10B, US32, US32D	AL, US3, US4, US10, US10B, US32, US32D

Exit Devices

ASSA ABLOY, the global leader in door opening solutions



3000 Series Functions: Standard Strikes				
3600 Series	<p>S12 Top Plate</p> <p>Standard strike. Stainless steel.</p>	<p>S13 Bottom Strike</p> <p>Standard strike. Furnished with expansion shields. Stainless steel.</p>		
	<p>S22 Top Strike</p> <p>Standard strike. Surface applied to stop. No mortise required. Black nylon coated.</p>	<p>S23 Bottom Strike</p> <p>Standard strike. Surface applied to threshold or floor. Black nylon coated.</p>	<p>S60</p> <p>For mounting top plate on doors with flush panel heads.</p>	
3700 Series	<p>S43 Bottom Strike</p> <p>Standard for SB3700. Alternate for S3700. No mortise required. Black nylon coated.</p>			
	<p>S38</p> <p>Standard strike for 3800. Surface applied.</p>	<p>S39</p> <p>Alternate for 3800. Fully mortised. Dimension "L" equal to 1/2" greater than door thickness. Nylon coating on lip only.</p>	<p>S36</p> <p>Double door strike. Alternate for 3800. Use on a pair of doors with a mullion.</p>	<p>S31</p> <p>Alternate for 3800. Half mortised. Nylon coating on face only.</p>
3900 Series	<p>S48C</p> <p>Standard for S3900. Curved lip ANSI A115.1. Handed. 1 1/4" lip standard. Longer lips available in 1/4" increments up to 2 7/8".</p>	<p>S48</p> <p>Alternate for S3900. Flat lip ANSI A115.1. Non-handed. 1 1/4" lip standard. Longer lips available in 1/4" increments up to 2 7/8".</p>	<p>S47</p> <p>Alternate for S3900. Open back ANSI A115.14. Beveled 1/8" in 2". Handed. Specify hand of active door.</p>	

Exit Devices

ASSA ABLOY, the global leader in door opening solutions



Certification & Compliance 

- ANSI/BHMA A156.3, Grade 1
- ANSI A117.1 Accessibility Code
- Underwriters Laboratories (UL and CUL) listed for accident hazard (panic) standard.
- Fire Exit hardware for hollow metal doors, UL and CUL listed for 3 hour, A label and lesser doors, Prefix "F" before part number.
- Fire Exit hardware for wood doors, listed up to 1-1/2 hour, B label doors.
- All exit devices comply with life safety code NFPA 101.
- All fire rated devices comply with fire door and window code NFPA80.



General Specifications

	4600	4800	4900
Chassis	Non-ferrous alloy	Non-ferrous alloy	Non-ferrous alloy
Chassis cover	Cold drawn brass, bronze or stainless steel	Cold drawn brass, bronze or stainless steel	Cold drawn brass, bronze or stainless steel
Door Types	Hollow metal or extruded aluminum	Wood, hollow metal or extruded aluminum	Wood or hollow metal
Door Thickness	1-3/4" (44.45mm) minimum	1-3/4" (44.45mm) minimum	1-3/4" (44.45mm) standard, up to 2-1/4" (57.15mm) available
Stile	Must be hollow, with inside dimension of at least 1-1/4" (31.75mm) at stile width and 1-3/8" (34.925mm) at thickness	1-3/4" (44.45mm) minimum	4-1/2" (114.30mm) minimum
Mounting	Supplied with machine screws	Supplied with wood and machine screws. Available with thru bolts.	Supplied with wood and machine screws. Available with thru bolts.
Handing	Handed. Specify LHRB or RHRB	Handed. Specify LHRB or RHRB	Handed. Specify LHRB or RHRB
Dogging	Allen-type standard. Available with cylinder dogging (suffix CD)	Allen-type standard. Available with cylinder dogging (suffix CD)	Allen-type standard. Available with cylinder dogging (suffix CD)
Top/bottom bolts	Stainless steel	N/A	N/A
Latchbolt	N/A	Stainless steel, 3/4" (19.05mm) throw	Brass, 3/4" (19.05 mm) throw
Rail	Roll formed brass, bronze or stainless steel	Roll formed brass, bronze or stainless steel	Roll formed brass, bronze or stainless steel
Rail Projection	3-1/4" (82.55mm) maximum	3-1/4" (82.55mm) maximum	3-1/4" (82.55mm) maximum
Opening Height	96" (2438.40mm) standard	N/A	N/A
Fire Exit Hardware-up to:	4' x 10' single door 8' x 10' pairs of doors	N/A N/A	4' x 8' single door 8' x 8' pairs of doors
Trim	See trim pages 15, 16	See trim pages 15, 16	See trim pages 15, 16
Finishes	US3, US4, US10, US10B, US32, US32D	US3, US4, US10, US10B, US32, US32D	US3, US4, US10, US10B, US32, US32D

Exit Devices

ASSA ABLOY, the global leader in door opening solutions





General Specifications

	S1150	S1250
Chassis & Cover	Non-ferrous alloy	Non-ferrous alloy
End caps	Metal	Metal
Doors	1-3/4" (44.45mm) thick wood or hollow metal 3-3/4" minimum stile for single doors 3-1/2" (88.90mm) minimum stile for double doors	1-3/4" (44.45mm) thick wood or hollow metal 4-1/2" (114.3mm) minimum stile 4-5/8" for fire-labeled devices
Handing	Reversible	Reversible
Dogging	Allen-type key standard, cylinder available.	Allen-type key standard, cylinder available.
Top/Bottom Bolts/ Latchbolt	Brass 1/2" (12.7mm) throw top, 3/4" (19.05mm) bottom	3/4" (19.05mm) throw, stainless steel
Throughbolts	Order separately	Order separately
Rail Assembly	Steel	Steel
Rail Size	Furnished standard for doors up to 36", can be cut down to accommodate 32" doors. Alternate rail sizes available for narrow or wide doors	Furnished standard for doors up to 36", can be cut down to accommodate 32" doors. Alternate rail sizes available for narrow or wide doors
Rods	90"-extension kits available	N/A
Trim	See trim page 4	See trim page 4
Finishes	AL, BRZ, LBZ (sprayed finishes)	AL, BRZ, LBZ (sprayed finishes)

Exit Devices

ASSA ABLOY, the global leader
in door opening solutions

Strikes - S1150 Series

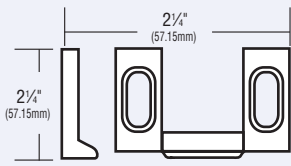

Standard Top Strike - S22
S22 top strike surface applied to stop, no mortise required. Black nylon coated, furnished standard.

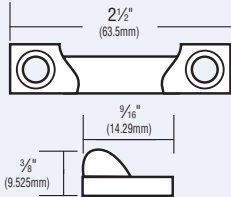

Standard Bottom Strike - S23
S23 bottom Strike surface applied to threshold or floor. Black nylon coated, furnished standard.

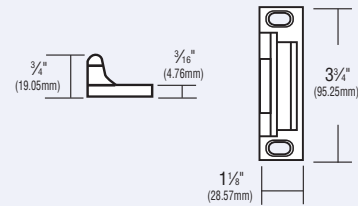

Fire Rated Top Strike - 646
Standard for FS1150. Surface applied. Nylon Coated.

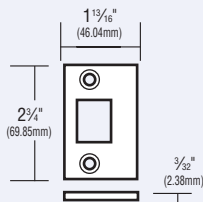

Fire Rated Bottom Strike - S655
Standard for FS1150. Flush mounted, stainless steel. Furnished with expansion shields.

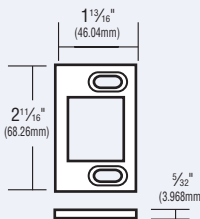

Sliding Bottom Bolt - S43
Alternate bottom strike for SVR.

Strikes - S1250 Series

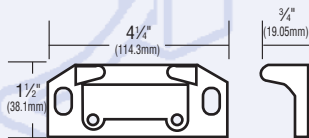

Fire Rated Surface Strike - S24
Surface applied nylon coated for fire labeled S1250

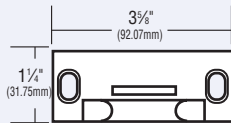

Standard Surface Strike - S38
Surface applied furnished standard.

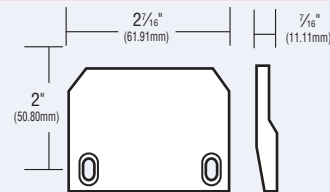

Double Door Strike - S36
Strike for double doors without mullion.

Parts

Chassis Covers, End Caps & Dogging Key

	Part No.
Chassis cover for 1150	28-0018
Chassis cover for 1250	28-0013
End cap for 1150 & 1250	28-0012
End cap mounting bracket	68-0080
Dogging Key	97-0001

Rail Assemblies - Standard Rail, Sprayed Finish

24" - 32" Doors	PR-24
32-1/4" - 36" Doors	PR-36
36-1/4" - 48" Doors	PR-48
Add "F" prefix for fire rated	

Rail Assemblies - Rail with Cylinder Dogging, Sprayed Finish

24" - 32" Doors	PR-24 CD
32-1/4" - 36" Doors	PR-36 CD
36-1/4" - 48" Doors	PR-48 CD

Extension Rod Kit for S1150 Series

18 inch	VRX-18
24 inch	VRX-24

**Exit Alarm, S1150 & S1250
Exit Device Trim**

Matching trim available to complement other series of cylindrical locks, B Series Mortise locks, exit devices and alarms.

Functions:

01: Passage

08: Dummy–Knob only.

12: Storeroom–Key retracts latch, only removable when locked.

17: Classroom–Key locks/unlocks outside knob/lever.

Ordering information:

When ordering trim, specify design symbol and function, eg: **BR12**, if specifying **Broadway** lever in **Storeroom** function.

Finish

US3, US4, US10, US10B, US26, US26D. (Knobs and levers)

AL, BRZ, RD. (SF Trim)

Lever Trim

<p>Sierra SR Lever: S Cast Rose: R Wrought</p>	<p>Broadway BR Lever: B Cast Rose: R Wrought</p>	<p>Ventura VR Lever: V Cast Rose: R Wrought</p>
---	---	--

Knob Trim

<p>Ball BD Knob: B Wrought Rose: D Wrought</p>	<p>Tudor TA Knob: T Wrought Rose: A Wrought</p>
---	--

Plate Trim

<p>SF01</p>	<p>SF02</p>	<p>SF03</p>	<p>SF12*</p>
--------------------	--------------------	--------------------	---------------------

*SF12 for S1250/FS1250 only.

Lever Trim Cover Plate

38-88A

- For use when retrofitting new style chassis or old style.
- Specify finish
- Order with new style exit device

Exit Devices

ASSA ABLOY, the global leader in door opening solutions

Arrow 1000 & 3000 Series Exit Device Trim

Optional Slip-Clutch Lever Design

- Optional slip-clutch is built in beneath security collar added to shank of lever.
- Available for use with SL88, SL33 and SL08 exit device trim for 1000 and 3000 Series Exit Devices. (Not available for S1150 or S1250 Series devices.)
- 

Vandal-resistant slip-clutch lever releases when excessive force is applied without retracting latch. Easily reset by returning lever to horizontal position.

EXIT DEVICE TYPE		
ANSI TYPE ARROW DEVICE		
Type 1	Rim	S1250, 1800, 3800
Type 2	Surface Vertical Rod	S1150, 1700, 3700
Type 3	Mortise	1900, 3900
Type 4	Narrow Stile Rim	4800
Type 6	Narrow Stile Concealed Vertical Rod	4600
Type 8	Metal Door Concealed Vertical Rod	3600
Type 10	Narrow Stile Mortise	4900
Type 22	Removable Mullion	S20, S21

EXIT DEVICE FUNCTION		
ANSI ARROW FUNCTION		
01	Exit only; no outside trim	01, 03
02	Entry by trim when actuating bar is locked	01, 02, 03
03	Entry by trim when latchbolt retracted by key. Key removable only when trim is locked.	03
05	Entry by thumbpiece when thumbpiece locked/unlock by key.	05
05A	Entry by thumbpiece; thumbpiece always operative, no outside cylinder.	5A
08	Entry by knob/lever; outside key locks, unlocks knob/lever.	08
08A	Entry by knob/lever; outside knob/lever always operative.	08A
11	Entry by auxiliary control turnpiece key locks, unlocks control.	11
12	Entry by auxiliary control turnpiece only when released by turning key. Key removable only when locked.	12

Exit Device Trim Functions

Function	1700/1700-FR	1800/1800-FR	1900/1900-FR
02*	SP, SS, SB, SN, SK, SL, SW	SP, SS, SB, SN, SK, SL, SW	SP, SS, SB, SN, SK, SL, SW
03	N/A	SP, SS, SB, SN, SK, SL, SW	SP, SS, SB, SN, SK, SL, SW
05	SP, SS, SB, SN	SP, SS, SB, SN	SP, SS, SB, SN
05A	SP, SS, SB, SN	SP, SS, SB, SN	SP, SS, SB, SN
08	SK, SL	SK, SL	SK, SL
08A			
11	S311	N/A	N/A
12	S312	N/A	N/A

Function	3600/3600-FR	3700/3700-FR	3800/3800-FR	3900/3900-FR
02*	SL, SW	SP, SS, SB, SN, SK, SL, SW	SP, SS, SB, SN, SK, SL, SW	SP, SS, SB, SN, SK, SL, SW
03	N/A	N/A	SP, SS, SB, SN, SK, SL, SW	SP, SS, SB, SN, SK, SL, SW
05	N/A	SP, SS, SB, SN	SP, SS, SB, SN	SP, SS, SB, SN
05A	N/A	SP, SS, SB, SN	SP, SS, SB, SN	SP, SS, SB, SN
08	SL	SK, SL	SK, SL	SK, SL
08A	SL	SK, SL	SK, SL	SK, SL
11	S411	S311	N/A	N/A
12	S412	S312	N/A	N/A

Function	4600/4600*-FR	4800	4900/4900-FR
02*	SL, SW	SL, SW	SP, SS, SB, SN, SL, SW
03	N/A	SL, SW	SP, SS, SB, SN, SL, SW
05	N/A	N/A	SP, SS, SB, SN
05A	N/A	N/A	SP, SS, SB, SN
08	SL	SL	SL
08A	SL	SL	SL
11	S511/UL-S411	N/A	N/A
12	S512/UL-S412	N/A	N/A

*02 not available fire rated.

Exit Devices

ASSA ABLOY, the global leader
in door opening solutions



Certification & Compliance

- ANSI/BHMA A156.3, Grade 1
- Underwriters Laboratories (UL and CUL) listed for accidoors,
- Made in the USA.

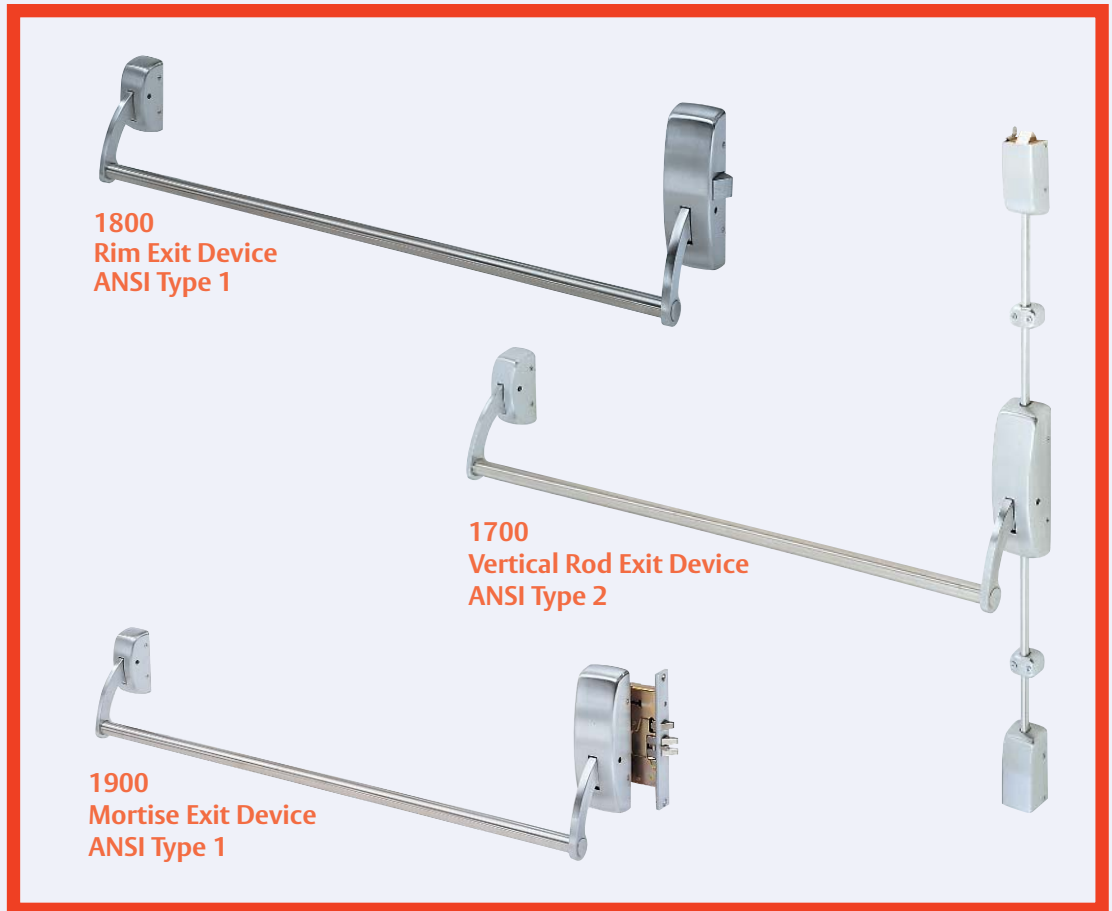

General Specifications

	1700	1800	1900
Chassis	Pressure formed non-ferrous alloy	Pressure formed non-ferrous alloy	Pressure formed non-ferrous alloy
Chassis and end covers	Cold drawn brass, bronze or stainless steel	Cold drawn brass, bronze or stainless steel	Cold drawn brass, bronze or stainless steel
Door Thickness	1-3/4" (44.45mm) standard, available for thick doors	1-3/4" (44.45mm) standard, available for thick doors	1-3/4" (44.45mm) standard, available for thick doors
Handing	Handed. Specify LHRB or RHRB	Handed. Specify LHRB or RHRB	Handed. Specify LHRB or RHRB
Dogging	Allen type only.	Allen type only.	Allen type only.
Top/Bottom Bolts	Brass	N/A	N/A
Latchbolt	N/A	Stainless steel, 5/8" (15.875mm) throw	Brass, 3/4" (19.05mm) throw
Crossbar Arms	Forged brass and stainless steel	Forged brass and stainless steel	Forged brass and stainless steel
Crossbar	1" (25.40mm) brass, bronze and stainless steel tubing, .062" (1.5875mm) thick	1" (25.40mm) brass, bronze and stainless steel tubing, .062" (1.5875mm) thick	1" (25.40mm) brass, bronze and stainless steel tubing, .062" (1.5875mm) thick
Crossbar projection	4-1/2" (114.3mm) neutral, 2-3/4" (69.85mm) depressed	4-1/2" (114.3mm) neutral, 2-3/4" (69.85mm) depressed	4-1/2" (114.3mm) neutral, 2-3/4" (69.85mm) depressed
Opening Height	90" (2286.00mm) standard	N/A	N/A
Fire Exit Hardware-up to:	4' x 7'2" single door 8' x 7'2" pairs of doors	4' x 7'2" single door 8' x 7'2" pairs of doors with S21 mullion	4' x 7'2" single door 8' x 7'2" pairs of doors (with 1700-FR)
Trim	See trim pages 15, 16	See trim pages 15, 16	See trim pages 15, 16
Finishes	US3, US4, US10, US10B, US32, US32D	US3, US4, US10, US10B, US32, US32D	US3, US4, US10, US10B, US32, US32D

Exit Devices

ASSA ABLOY, the global leader in door opening solutions



ASSA ABLOY

Certification & Compliance

- ANSI/BHMA A156.3, Grade 1
- Underwriters Laboratories (UL and CUL) Listed for accident hazard (panic) standard.
- Fire Exit hardware for hollow metal doors, UL and CUL listed for 3 hour, A label and lesser doors, Suffix “-FR” after part number.
- Fire Exit hardware for wood doors, listed up to 1-1/2 hour, B label doors
- All exit devices comply with life safety code NFPA 101
- All fire rated devices comply with fire door and window code NFPA80.



600 Series Vertical Rod Exit Device

500 Series Rim Exit Device

General Specifications

	500	600
Chassis	Non-ferrous materials	Non-ferrous alloy
Chassis Cover	Black Lexan	Black Lexan
Door Type	Hollow metal or aluminum	Hollow metal or aluminum
Door Thickness	1-3/4" (44.5mm) thick doors standard. 500DK Kits available for use with 161 door prep	1-3/4" (44.5mm) thick doors standard. 500DK Kits available for use with 161 door prep
Stile	4-1/2" (144.30mm) minimum	3-1/2" (144.30mm) minimum
Mounting	Wood and Machine screws furnished standard	Wood and Machine screws furnished standard
Handing	Reversible	Reversible
Dogging	Hex-type hold down not available with fire rated devices	Hex-type hold down not available with fire rated devices
Latchbolt	Stainless Steel	Top bolt - stainless; Bottom bolt - brass, -FR top and bottom bolts - stainless
Rail Assembly	Powder Coated Steel	Powder Coated Steel
Fire Exit Hardware-up to:	4' x 8' single door, 8' x 8' pairs of doors	8' x 8'
Trim	Existing 1100 and 1200 trim designs will work	Existing 1100 and 1200 trim designs will work
Finishes	Exit devices & Pulls: AL & DBZ, Lever Trim 10B & 26D	Exit devices & Pulls: AL & DBZ, Lever Trim 10B & 26D
Strike	S38 Strike	Top 646, Bottom S23
Size		90" Standard, Optional door height available 96"
Door Width	530 Device is for 36" door can be cut for a minimum 30" door width. 540 Device is for 48" door can be cut for a minimum 37" door width	630/638 Device is for 36" door can be cut for a minimum 30" door width. 640/648 Device is for 48" door can be cut for a minimum 37" door width

Exit Devices

ASSA ABLOY, the global leader in door opening solutions



ASSA ABLOY

Mullions & Accessories

S20

2 1/2" (63.5mm)
1 1/2" (38.1mm)
3" (76.2mm)
1 1/4" (131.75mm)

Removable Mullion - S20

- Prime Coated aluminum
- 96" standard, 120" available
- Finished standard with top retainer (S10) and bottom retainer (S11)

S21

2" (50.80mm)
3" (76.2mm)

Removable Mullion - S21

- U.L. and C.U.L. Labeled for use with 3 hour fire doors.
- 2" x 3" channel iron;
- 96" standard, 120" available
- Furnished standard with malleable iron top retainer (S88) and bottom retainer (S89).
- Lengths from 97" to 120" do not carry U.L. fire label.

S20-N

1 1/2" (25.9mm)
2 1/2" (63.5mm)
1" (25.4mm)
2 3/4" (19.84mm)

S20-N

- Prime coated aluminum
- 96" standard, 120" available
- For use with narrow stile exit devices.
- Includes mullion, two #S55 strikes, two #S90 stabilizers, #S91 top bracket, #S92 bottom bracket.

S91

S92

S3000 Dummy Rail

A non-functioning rail assembly for use on double doors. Matches S3000 and S4000 series exit devices. Available in sizes 24 (for 24"-29" doors), 36 (for 30"-36" doors), 48 (for 37"-48" doors). Bars can be cut down in the field. For stile width under 4-1/2", specify next larger size. Available in finishes - 3, 4, 10, 10B, 32, 32D, AL, BRZ.

Cylinder Dogging Rail

- Optional cylinder dogging available

VRX-18 Rod Extension

- Prime Coated aluminum
- 96" standard, 120" available
- Furnished standard with top retainer (S10) and bottom retainer (S11)

Mullions

Description	Part No.
Removable mullion - 96"	S20
Removable Mullion - 120"	S20-120
Key removable mullion - 96"	S20-KR
Removable mullion for narrow stile - 96"	S20-N
Removable mullion for narrow stile - 120"	S20-N-120
Fire-rated removable mullion - 96"	S21
Fire-rated key removable mullion - 96"	S21-KR
Top retainer for S20	S10
Bottom retainer for S20	S11
Top retainer for S20-N	S91
Bottom retainer for S20-N	S92
Stabilizer for S20-N	S90
Top retainer for S21	S88
Bottom retainer for S21	S89

Selection chart for A through E labeled doors

For reference only. Refer to latest UL building materials list for complete information.

Application	Type	Narrow Device	Standard Device	Maximum Door Opening
Single Door	Rim	—	FS1250 1800-FR 3800-FR	4'0" x 8'0"
	Mortise	4900-FR	1900-FR 3900-FR	4'0" x 8'0"
Double Doors with S21 Mullion	Rim	—	FS1250 x FS1250 1800-FR x 1800-FR 3800-FR x 3800-FR	8'0" x 8'0"
	Mortise x concealed vertical rod	4900-FR x 4600-FR	3900-FR x 3600-FR	8'0" x 8'0"
Double Doors without Mullion	Mortise x surface vertical rod	—	1900-FR x 1700-FR 3900-FR x 3700-FR	8'0" x 8'0"
	Two concealed vertical rod	4600-FR x 4600-FR	3600-FR x 3600-FR	8'0" x 8'0"
	Two surface vertical rod	—	FS1150 x FS1150 1700-FR x 1700-FR 3700-FR x 3700-FR	8'0" x 8'0" (B-E)
Double Egress Doors	Two concealed vertical rod	4600-FR x 4600-FR	3600-FR x 3600-FR	8'0" x 7'2" (A) 8'0" x 8'0" (B-E)
	Two surface vertical rod	—	FS1150 x FS1150 1700-FR x 1700-FR 3700-FR x 3700-FR	8'0" x 7'2" (A) 8'0" x 8'0" (B-E)

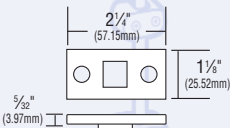
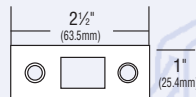
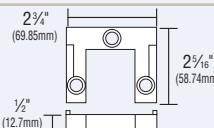
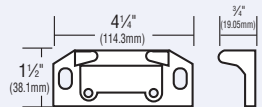
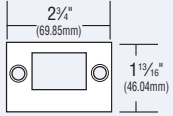
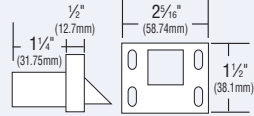
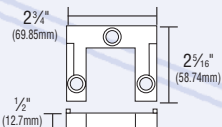
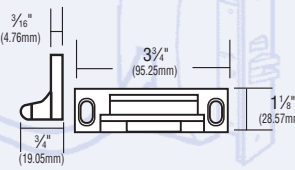
 <p>S13 Bottom Strike Stainless steel. Furnished with expansion shields. Stainless steel.</p>	 <p>S14 For application to wood or hollow metal doors.</p>	 <p>S15 Bottom Strike Alternate for 1700-FS. For use on 1/2" threshold. Stainless steel. Furnished with expansion shields.</p>	 <p>S24 F-400 Series standard for single door applications. Black nylon coated.</p>
 <p>S45 Standard for F-S1700. Flush mounted. Stainless steel. Furnished with expansion shields.</p>	 <p>S46 Bottom Strike Standard for F-S1150, F-S3700. Flush mounted. Furnished with expansion shields. Stainless steel, black nylon coated.</p>	 <p>S58 Bottom Strike Alternate for F-S1150, 3700-FS. For use on 1/2" threshold. Stainless steel, nylon coated. Furnished with expansion shields.</p>	 <p>646 Fire Rated Top Strike Standard for FS1150 and 3700-FR. Surface applied. Nylon Coated</p>

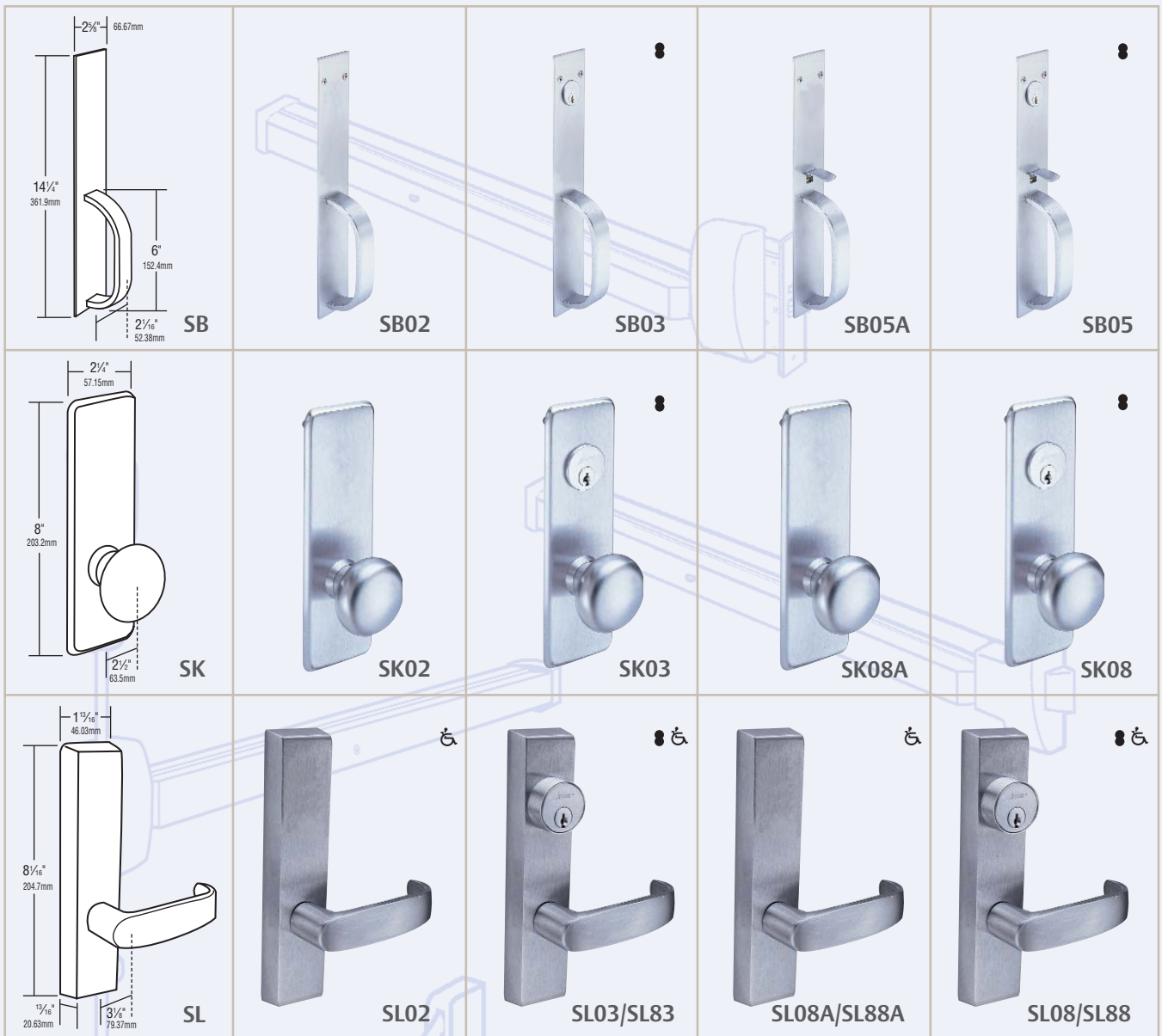

Exit Devices

ASSA ABLOY, the global leader in door opening solutions



ASSA ABLOY

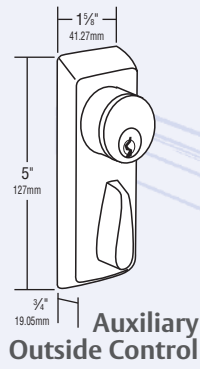

- **S311**—Use with S3700, FS3700, S1700, FS1700. Key locks or unlocks turn lever.
- **S312**—Use with S3700, FS3700, S1700, FS1700. Turn lever operative only with key in cylinder and turned.
- **S411**—Use with S3600, FS3600, FS4600. Key locks or unlocks turn lever.
- **S412**—Use with S3600, FS3600, FS4600. Turn lever operative only with key in cylinder and turned.
- **S511**—Use with S4600. Key locks or unlocks turn lever.
- **S512**—Use with S4600. Turn lever operative only with key in cylinder and turned.

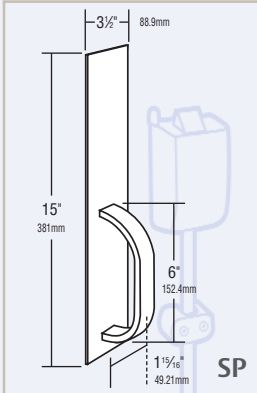

SP02/SP82



SP03/SP83



SP05A



SP05

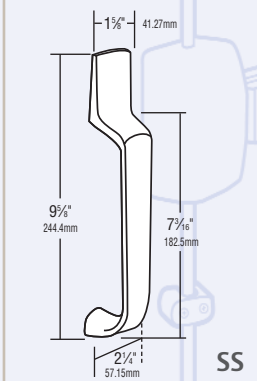

SS02/SP82



SS03/SP83



SS05A



SS05

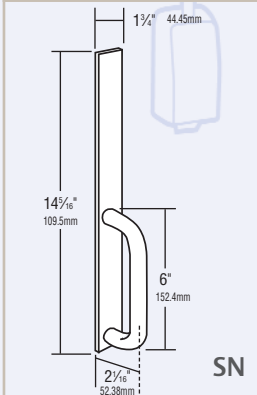

SN02/SN82



SN03/SN83



SN05A



SN05

Exit Devices

ASSA ABLOY, the global leader in door opening solutions



ASSA ABLOY

For reference only. Refer to latest UL building materials list for complete information.

Application	Type	Narrow Stile Touch Bar	Standard Touch Bar	Crossbar
Single Door	Rim	4800	S1250, FS1250 3800, 3800-FR	1800, 1800-FR
	Vertical Rod	—	S1150, FS1150 3700, 3700-FR	Mortise
	Concealed Vertical Rod	4600, 4600-FR	3600, 3600-FR	Mortise
	Mortise	4900, 9600-FR	3900, 3900-FR	Mortise
Double Doors with Mullion	Rim	4800 x 4800 with S20-N mullion	S1250 x S1250 3800 x 3800 with S20 mullion FS1250 x FS1250 3800-FR x 3800-FR with S21 mullion	Mortise
Double Doors without Mullion	Concealed Vertical Rod	4600 x 4600 4600-FR x 4600-FR	3600 x 3600 3600-FR x 3600-FR	Mortise
	Vertical Rod	—	S1150 x S1150 FS1150 x FS1150 S3700 x S3700 3700-FR x 3700-FR	Mortise
	Vertical Rod x Mortise	—	3700 x 3700 3700-FR x 3700-FR	Mortise



Exit Devices

ASSA ABLOY, the global leader
in door opening solutions



ASSA ABLOY

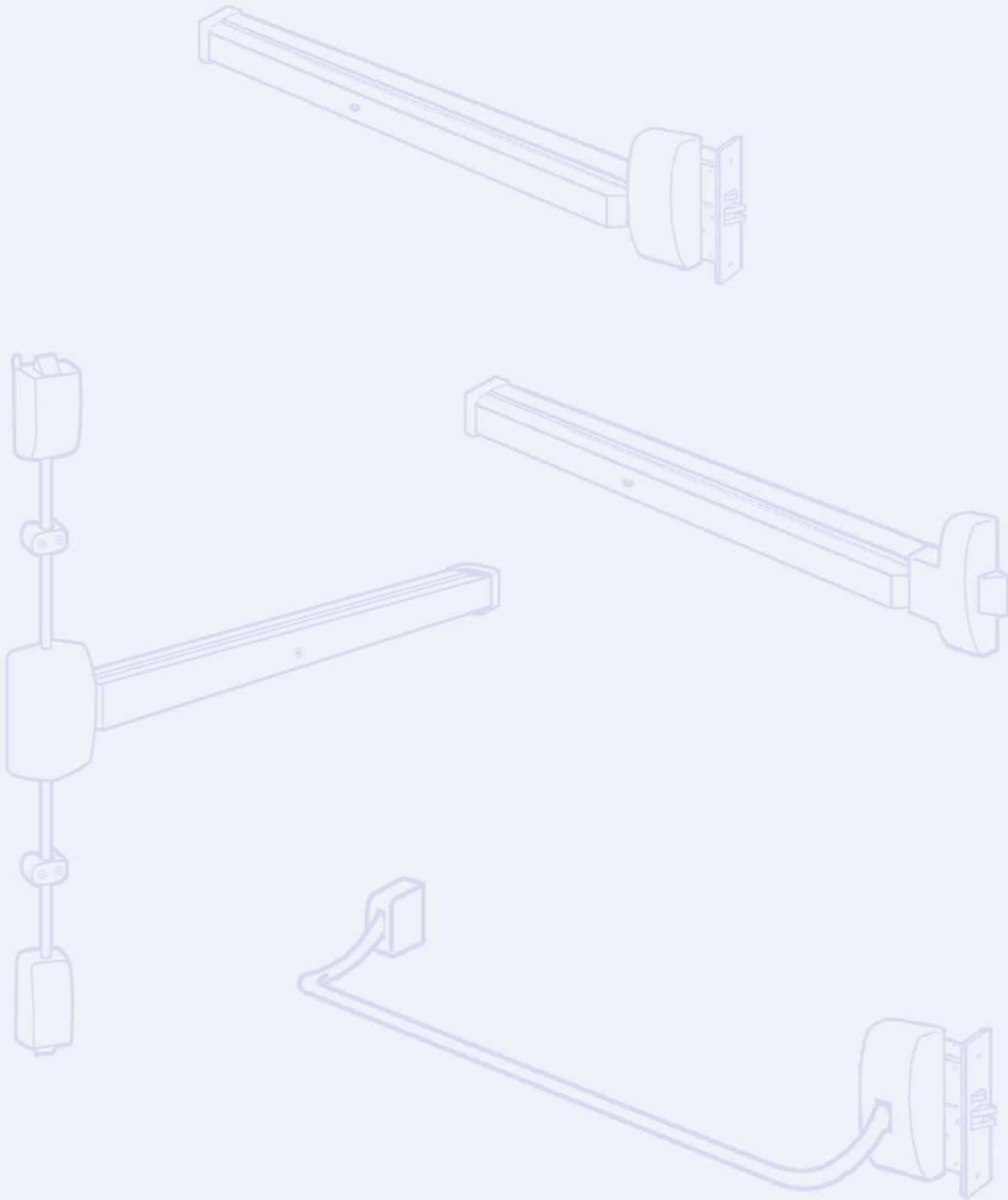

Exit Devices

ASSA ABLOY, the global leader in door opening solutions



ASSA ABLOY



ASSA ABLOY

ARROW USA

Phone: 800-839-3157

Fax: 800-421-6615

ARROW CANADA

Phone: (905) 940-2040

Fax: (905) 940-3242

Visit us at our Website:

www.arrowlock.com

For more information regarding
Arrow locksets, exit devices,
door closers and key systems,
contact your authorized
Arrow distributor.

ASSA ABLOY is the
global leader in door
opening solutions
dedicated to satisfying
end-user needs for
security, safety and
convenience.